

LTECH

DMX/RDM
Signal Amplifier



Product Features

- Used in the DMX/RDM lighting control system.
- Automatically recognize DMX/RDM signals.
- 1 channel input, 16 channel outputs; multiple channel outputs to increase DMX device number.
- Relay function for amplifying weak DMX/RDM signals and extending the signal transmission distance.
- BYPASS function for expanding DMX device number.
- Independent photoelectric isolation between the input and the outputs to improve overall security and reliability of the lighting control system.
- Neutrik 3-pin XLR, 5-pin XLR connectors ensure security and reliability.
- Standard 1U rack-mounted signal amplifier. Be ready to use out of the rack mount cabinet.
- Used in TV broadcast lighting, stage lighting, entertainment venue lighting, etc.



Package Contents

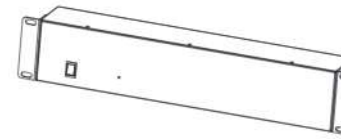

Signal amplifier x1

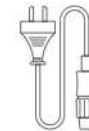

Aviation plug x1

Technical Specs

Product model	RDM-AMP-16E	RDM-AMP-16
Input voltage	100-240V~, 50/60Hz	
Input signal	1CH DMX/RDM signal input (photoelectric isolation>3KV)	
Output signal	16CH DMX/RDM signal outputs (photoelectric isolation>3KV) 1CH OUTPUT (BYPASS)	16CH DMX/RDM signal outputs (photoelectric isolation>3KV) 1CH OUTPUT (BYPASS)
Input port	5 -pin XLR×1	3-pin XLR×1
Output port	5-pin XLR×16	3-pin XLR×16
Working temperature	-20°C-55°C	
Dimensions	486.5×88×85mm(L×W×H)	
Package size	525×169×127mm(L×W×H)	
Net weight	1922g	

Product Size

Unit: mm

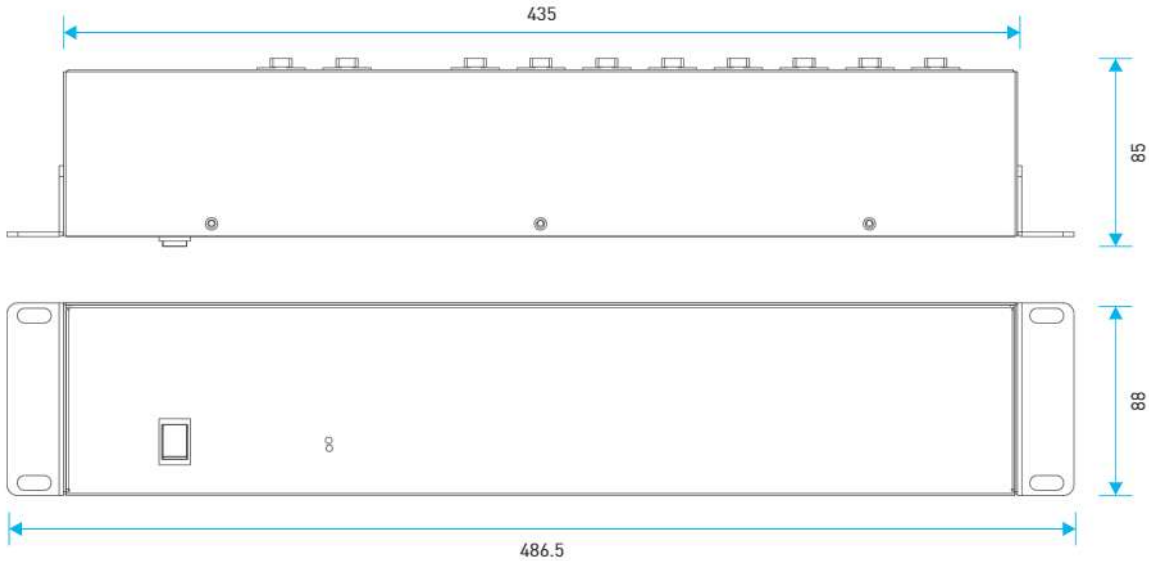

Overview

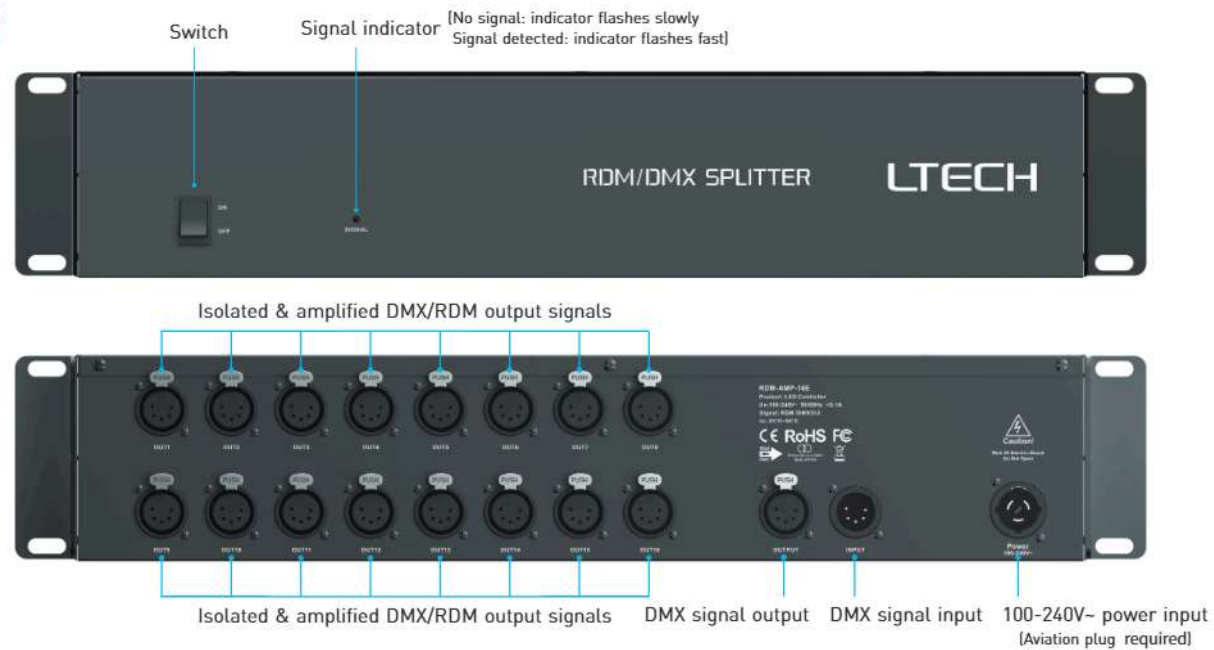

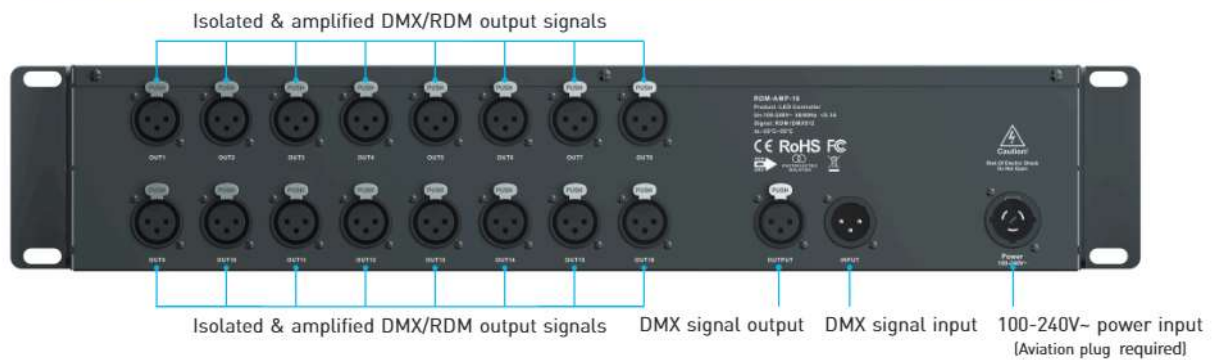
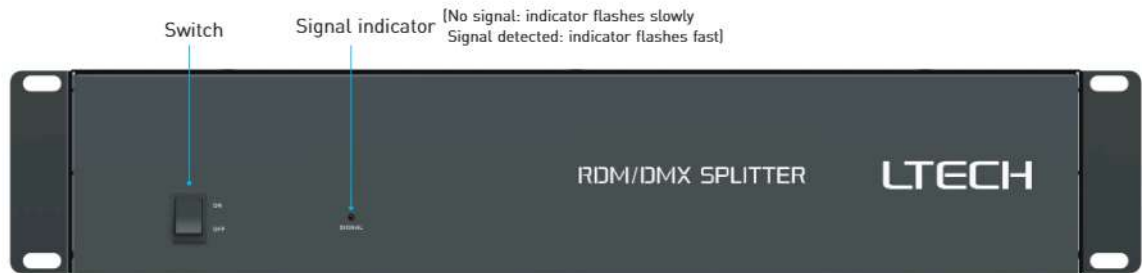

Power cord replacement diagram

This product includes a power cord. If it is not applicable, you can replace this power cord depending on your need.

- ① A 3-core 2.5mm cable is needed for the aviation plug.



- ③ Use a screwdriver to unscrew the screws on the wire connector and remove the original power cord, then replace with a new one.



- ② Unscrew the anti loose nut and the waterproof silicone wire shell first, then push the wire connector out of the 3-core cold shrinkable copper terminal

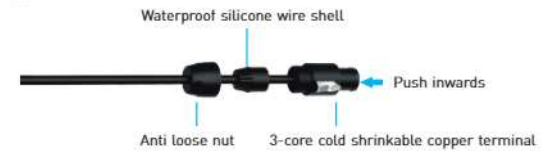

Note: Cable installation

The exposed cable wires need to be tinned. Then insert the cables deep down into the terminal block of the plug, and tighten the terminal screws. Please note that the wire clamp is used to fasten the cable, not the exposed wires.

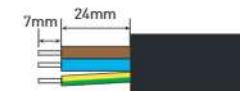

RDM-AMP-16E

Connection diagram of relay mode

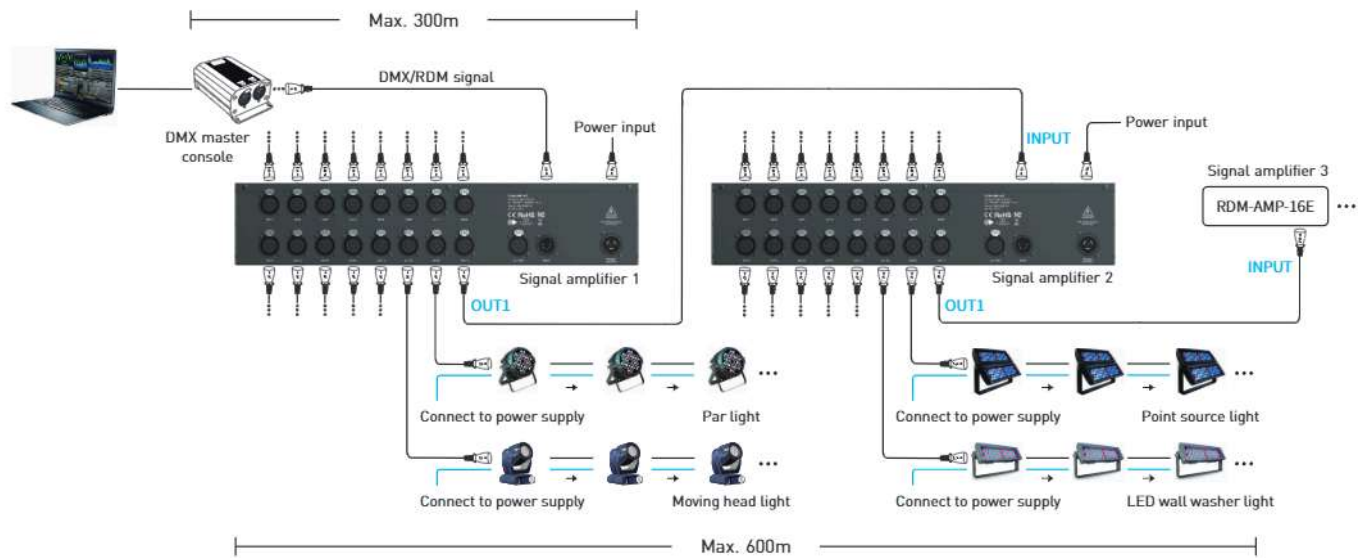

RDM-AMP-16E

Connection diagram of extended mode

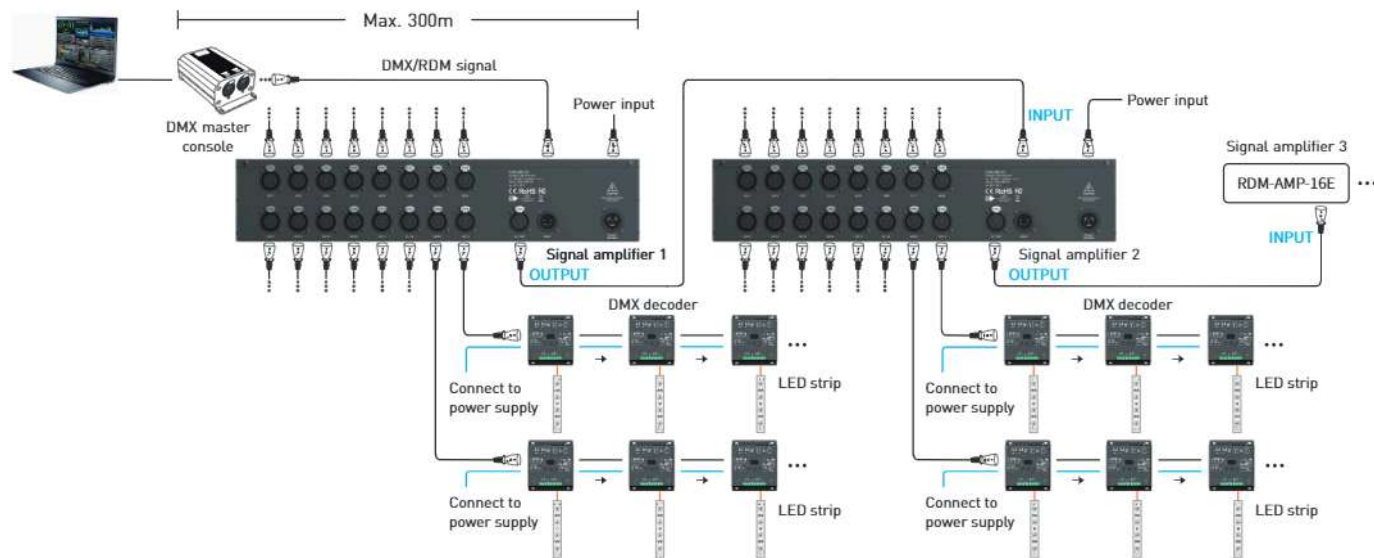

RDM-AMP-16

Connection diagram of relay mode

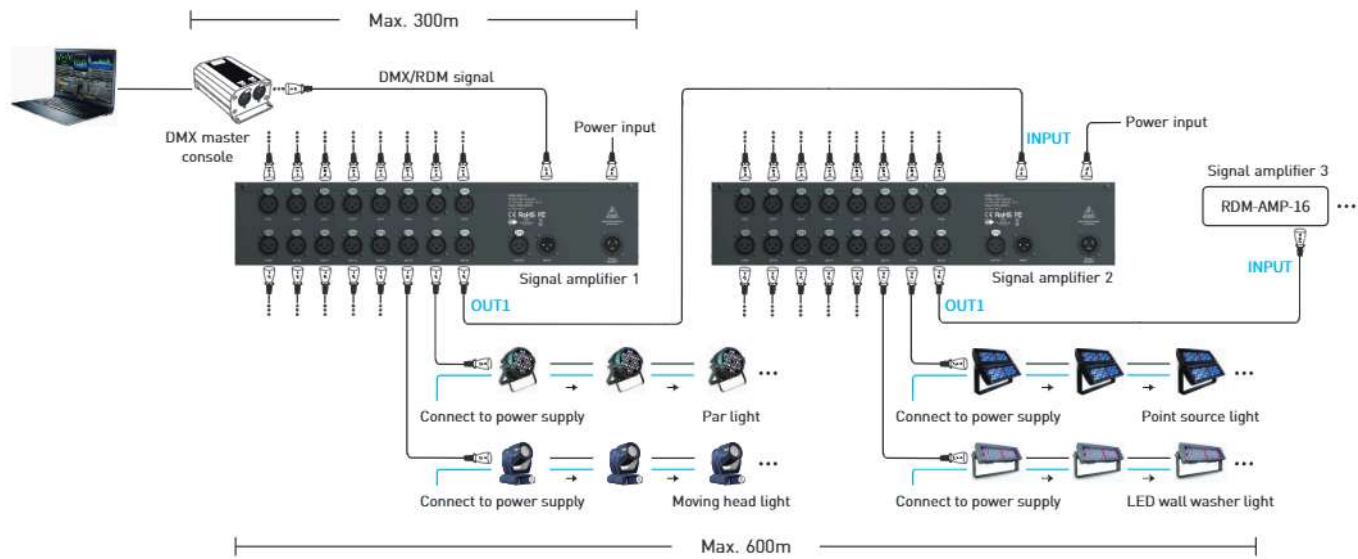

RDM-AMP-16

Connection diagram of extended mode

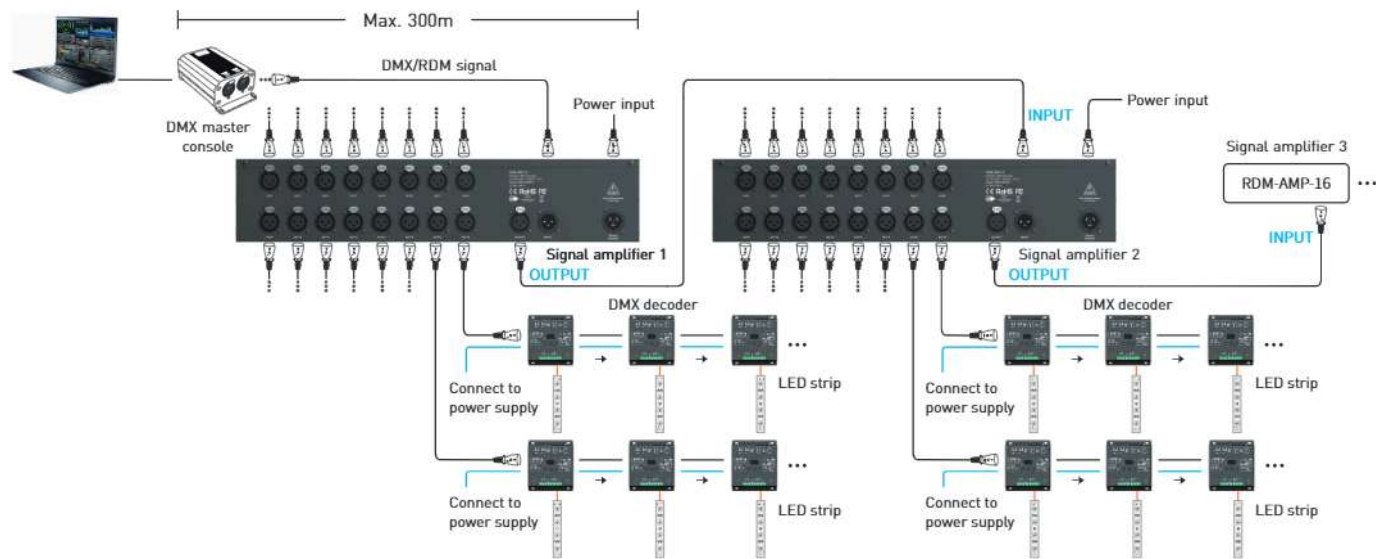

Work with a RDM Programmer

DMX/RDM signal amplifier can work with a RDM programmer that follows the standard RDM protocol.

It is recommended to use the LTECH RDM Programmer (Model: WiFi-RDM01), which allows users to remotely browse & set parameters, DMX address via the mobile APP.

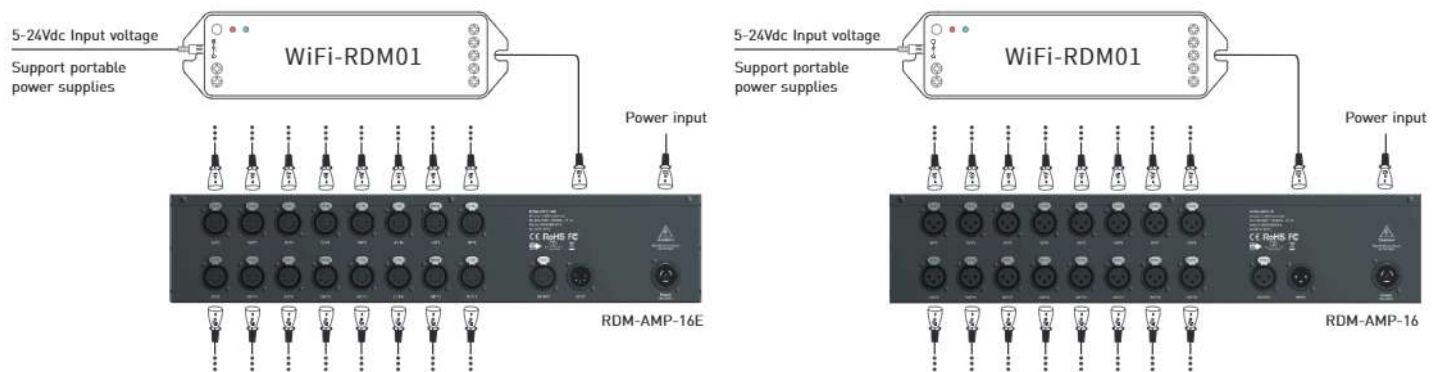

Mobile App Interfaces for the RDM Programmer

Download the App with your mobile phone and connect to the RDM Programmer successfully, then you are allowed to set parameters through the APP. Please refer to the WiFi-RDM01 manual for more details.

- a. At the homepage, click "Add" of the device you are going to edit the address, as shown below in the interface.
- b. Click "ID" to get more details for devices.
- c. Click "No" to issue a recognizing command.
- d. Click "⚙️" in the upper left corner to access the settings which allows you to test, edit DMX addresses, etc.



Home page



Test

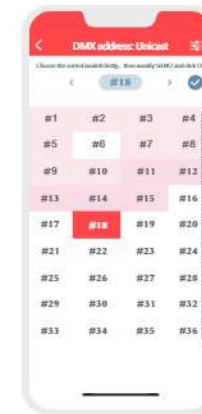

DMX address setting

Transportation and Storage

1. Transportation

Products can be shipped via vehicles, boats and planes.

During transportation, products should be protected from rain and sun. Please avoid severe shock and vibration during the loading and unloading process.

2. Storage

The storage conditions should comply with the Class I Environmental Standards. The products that have been stored for more than six months are recommended to be re-inspected and can be used only after they have been qualified.

Attentions

- Product installation and commissioning should be done by a qualified professional.
- This product is non-waterproof (special models excepted). Please avoid the sun and rain. When installed outdoors, please ensure it is mounted in a water proof enclosure.
- Good heat dissipation will extend the life the product. Please install the product in a environment with good ventilation.
- Please check whether the working voltage used complies with the parameter requirements of the product.
- Before you power on the product, please make sure all the wiring is correct in case of incorrect connection that may cause a short circuit and damage the components, or trigger a accident.
- If a fault occurs, please do not attempt to fix the product by yourself. If you have any question, please contact the supplier.

Warranty Agreement

- Warranty periods from the date of delivery: 5 years.
- Free repair or replacement services for quality problems are provided within warranty periods.

Warranty exclusions below:

- Beyond warranty periods.
 - Any artificial damage caused by high voltage, overload, or improper operations.
 - Products with severe physical damage.
 - Damage caused by natural disasters and force majeure.
 - Warranty labels and barcodes have been damaged.
 - No any contract signed by LTECH.
1. Repair or replacement provided is the only remedy for customers. LTECH is not liable for any incidental or consequential damage unless it is within the law.
 2. LTECH has the right to amend or adjust the terms of this warranty, and release in written form shall prevail.

* This manual is subject to changes without further notice. Product functions depend on the goods. Please feel free to contact our official distributors if you have any question.

Update Time: 09/05/2024_A0



www.ltech-led.com

ZHUHAI LTECH TECHNOLOGY CO., LTD.

1st Building, No. 183, Shui'an 1st Road, Xiangzhou District,
519060 Zhuhai City, PEOPLE'S REPUBLIC OF CHINA