

## Intelligent Tunable White LED Driver (Constant Current)

- The housing is made from V0 flame retardant PC materials from SAMSUNG/COVESTRO.
- Ultra-small, thin and light screwless end cap.
- Change the output current, fade time and other parameters on the NFC programmer or via the App, and sync the parameters to the driver.
- Set the output current down to 1mA.
- With soft-on and fade-in dimming function, enhancing your visual comfort.
- T-PWM™ Super depth dimming technology, dimming depth can reach 0.0001%
- The whole dimming process is flicker-free with high frequency exemption level.
- Comply with the EU's ErP Directive, networked standby<0.5W.
- When there is no load, the output will be 0V to prevent damage to LEDs due to poor contact.
- Overheat, over voltage, overload, short circuit protection and automatic recovery.
- Suitable for Class I / II / III indoor light fixtures.
- Normal service life can reach 100,000 hours.
- 5-year warranty (Rubycon capacitor)



DIM / CT

**T-PWM™**  
Dimming Technology

**Flicker Free**  
IEEE 1789

Dimmable:  
■■■■■■■■■■  
1000000:1

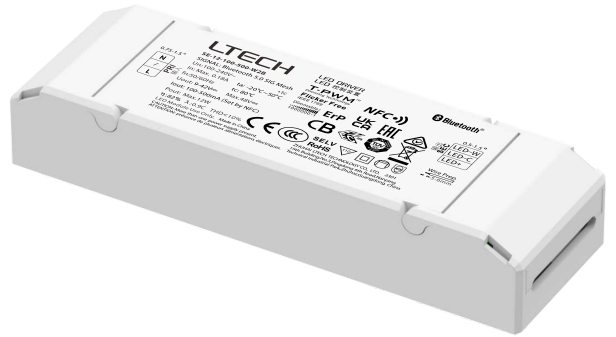

The certification icon represents undergoing certification applications only, and final certification qualification subject to actual product.



## Technical Specs

Model	SE-12-100-500-W2B			
Features	Output Type	Constant current		
	Dimming Interface	Bluetooth 5.0 SIG Mesh		
	Output Feature	Isolation		
	Protection Grade	IP20		
OUTPUT	Insulation Grade	Class II (Suitable for class I / II / III light fixtures)		
	Output Voltage	9-42Vdc		
	Maximum output voltage	≤48Vdc		
	Output Current Range	100-500mA		
	Output Power Range	0.9W-12W		
	Dimming Range	0-100%, down to 0.0001%		
	LF Current Ripple	<3%(Maximum current for non dimming state)		
	Current Accuracy	±5%		
INPUT	PWM Frequency	≤3600Hz		
	DC Voltage Range	120-250Vdc		
	AC Voltage Range	100-240Vac		
	Input Voltage	115Vac/230Vac		
	Frequency	50/60Hz		
	Input Current	≤0.18A/115Vac, ≤0.08A/230Vac		
	Power Factor	PF>0.95/115Vac (at full load), PF>0.9C/230Vac (at full load)		
	THD	THD≤10%/230Vac, at full load		
	Efficiency (Typ.)	84%@300mA(at full load), 82%@500mA(at full load)		
	Inrush Current	Cold start 15A(Test twidth=102us tested under 50% Ipeak)/230Vac		
ENVIRONMENT	Anti Surge	L-N: 2KV		
	Leakage Current	Max. 0.5mA		
	Working Temperature	ta: -20 ~ 50°C tc: 80°C		
	Working Humidity	20 ~ 95%RH, non-condensing		
	Storage Temperature/Humidity	-40 ~ 80°C/10-95%RH		
PROTECTION	Temperature Coefficient	±0.03%/°C[0-50°C]		
	Vibration	10-500Hz, 2G 12min/1cycle, 72 min for X, Y and Z axes respectively		
	Overload Protection	Automatically protect the device when the load exceeds 102% of the rated power. Automatically recover once load is reduced		
	Overheat Protection	Intelligently adjust or turn off the current output if the PCB temperature ≥110°C. When the PCB temperature <90°C, automatically recover normal output		
SAFETY & EMC	Overvoltage Protection	Automatically protect the device when voltage exceeds the no-load voltage. It can be recovered automatically		
	Short Circuit Protection	Enter hiccup mode if short circuit occurs, and recover automatically		
SAFETY & EMC	Withstand Voltage	I/P-O/P: 3750Vdc		
	Insulation Resistance	I/P-O/P: 100MQ/500VDC/25°C/70%RH		
	Safety Standards	CCC	China	GB19510.1, GB19510.14
		TUV	Germany	EN61347-1, EN61347-2-13, EN62493
		CB	CB Member States	IEC61347-1, IEC61347-2-13
		CE	European Union	EN61347-1, EN61347-2-13, EN62384
		KC	Korea	KC61347-1, KC61347-2-13
		EAC	Russia	IEC61347-1, IEC61347-2-13
		RCM	Australia	AS 61347-1, AS 61347-2-13
		ENEC	Europe	EN61347-1, EN61347-2-13, EN62384
		UKCA	Britain	BS EN 61347-1, BS EN 61347-2-13, BS EN 62493
		BIS	India	IS 15885 (PART 2/SEC 13)
	CUL	Canada	CSA C22.2 NO.250.13	
	UL	America	UL 8750	
	EMC Emission	CCC	China	GB/T17743, GB17625.1
CE		European Union	EN55015, EN61000-3-2, EN61000-3-3, EN61547	
KC		Korea	KSC 9815, KSC 9547	
EAC		Russia	IEC62493, IEC61547, EH55015	
RCM		Australia	EN55015, EN61000-3-2, EN61000-3-3, EN61547	
UKCA		Britain	BS EN IEC 55015, BS EN IEC 61000-3-2, BS EN 61000-3-3, BS EN 61547	
CUL	Canada	ICES-005		
UL	America	FCC PART 15B		
EMC Immunity	EN61000-4-2,3,4,5,6,8,11, EN61547			
ErP	Power Consumption	Networked standby	<0.5W (After shutdown by command)	
		No-load power consumption	<0.5W (When the lamp is not connected)	
	Flicker/Stroboscopic Effect	IEEE 1789	Meet IEEE 1789 standard/High frequency exemption level	
OTHERS		CIE SVM	Pst LM≤1.0, SVM≤0.4	
	DF	Phase factor	DF≥0.9	
OTHERS	Weight(N.W.)	85g±10g		
	Dimensions	110×35×20mm(L×W×H)		

Product Size

Unit: mm

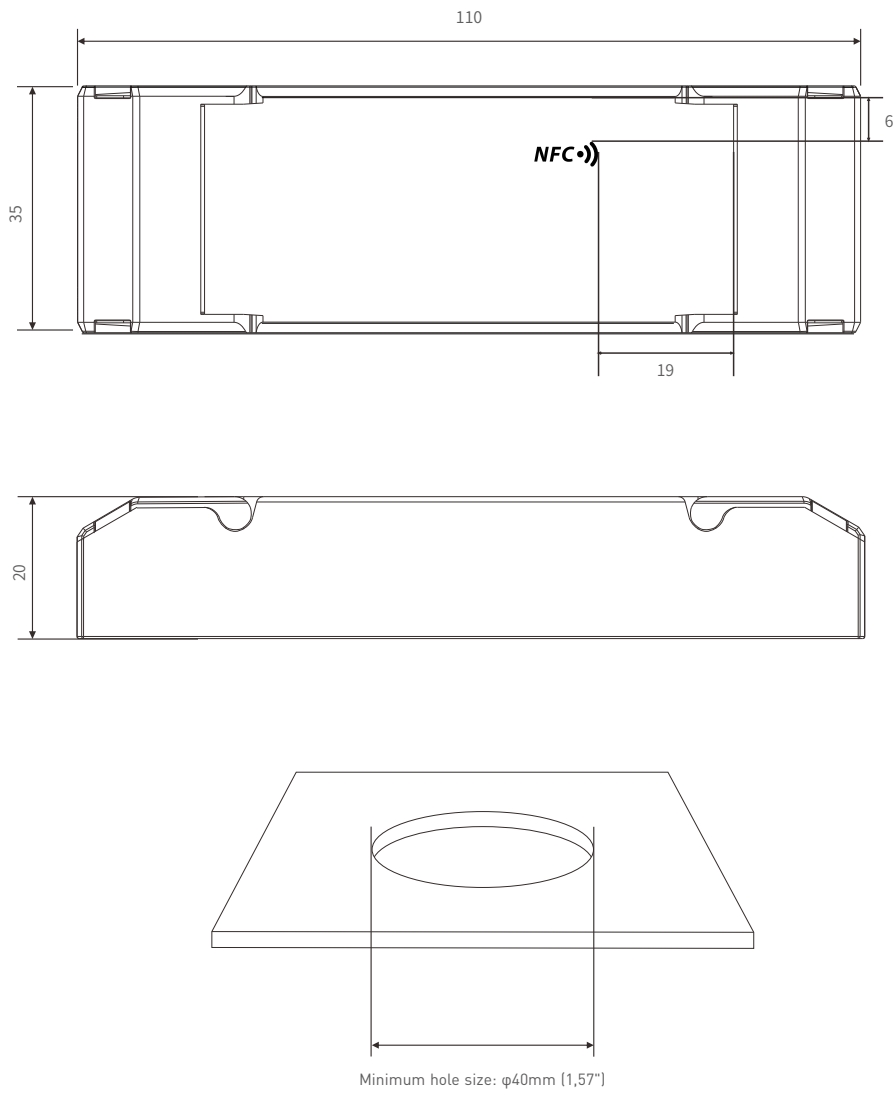

Wiring Diagram

Wireless connection mode

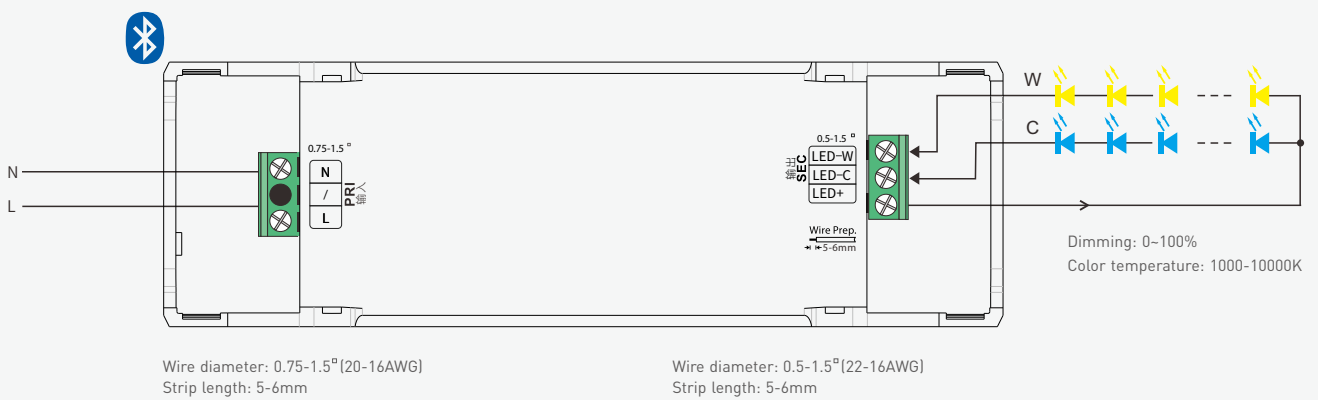

\* Access the network to control through App and Bluetooth

Table of Typical Corresponding Parameters for Current

The typical 9 current data sets below are for reference when selecting LED fixture models. More current levels can be set by NFC using mobile APP with 100-500mA adjustable in 1mA step

<b>Output Current</b>	100mA	150mA	200mA	250mA	300mA
<b>Output Voltage</b>	9-42Vdc	9-42Vdc	9-42Vdc	9-42Vdc	9-40Vdc
<b>Output Power</b>	0.9-4.2W	1.35-6.3W	1.8-8.4W	2.25-10.5W	2.7-12W
<b>Output Current</b>	350mA	400mA	450mA	500mA	/
<b>Output Voltage</b>	9-34Vdc	9-30Vdc	9-27Vdc	9-24Vdc	/
<b>Output Power</b>	3.15-11.9W	3.6-12W	4.05-12.15W	4.5-12W	/

Protective Housing Application Diagram

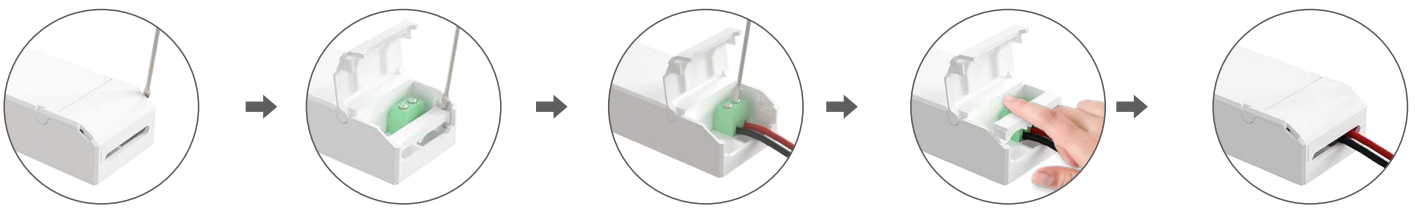

1. Use a tool to pry up the protective housing on the side panel.
2. Pry up the protective housing in the side plate position with a tool.
3. Connect to electrical wires with a screwdriver as wiring diagram shows.
4. Press down the tension plate to fix the the electrical wires.
5. Close the protective housing.

Installation Precautions

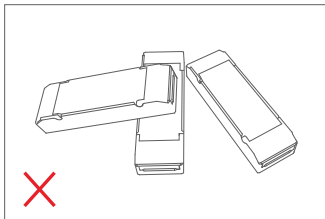

Please do not stack the products. The distance between two products should be  $\geq 15\text{cm}$  so as not to affect heat dissipation and the lifespan of the products.

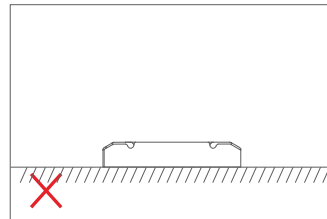
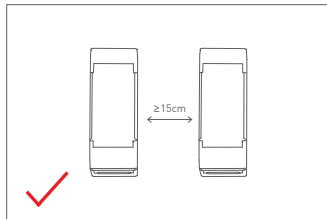

Please do not place the products on the floor. The distance between the product and the floor should be  $\geq 100\text{cm}$  so as to avoid signal interference.

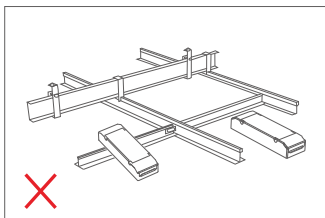
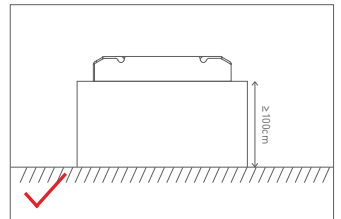

Please do not place the products near a large area of metal objects (such as metal stud ceilings). The distance between the product and the metal object should be  $\geq 15\text{cm}$  so as to avoid signal interference.

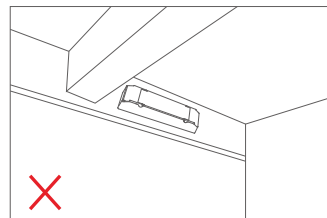
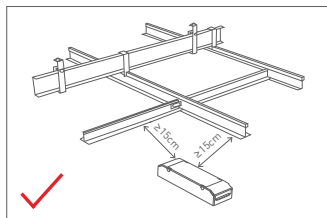

Please do not install the products on beams or near the corners. The distance between the product and the beam or the corner should be  $\geq 15\text{cm}$  so as to avoid signal interference.

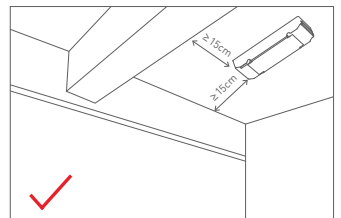

Note: The temperature within the installation area should be within the working temperature range of the products. Please do not install products inside LED fixtures to avoid temperature exceeding the working temperature that may affect the product lifetime.

## Use the NFC Lighting APP

Scan the QR code below with your mobile phone and follow the prompts to complete the APP installation (According to performance requirements, you need to use a NFC-capable Android phone, or an iPhone 8 and later that are compatible with iOS 13 or higher).



\* Before you begin setting the parameters of the driver on the NFC programmer or via the APP, please make sure the driver is powered off.

### Read/Write the LED driver

Use your NFC-capable phone to read the driver parameters, then set the output current, fade time, power-on status, other parameters. Save your settings and hold your phone close to the driver again, so the parameters can be easily written to the driver.

#### 1. Read the LED driver

On the APP home page, click [Read/Write LED driver], then keep the programmer's sensing area close to the NFC logo of the driver to read the driver parameters.



#### 2. Edit the parameters

Click [Parameter settings] to edit the advanced parameters, like output current, time for fading on/off, power-on fading time, power-on status, etc.

#### 3. Write to the driver

After completing the parameter settings, click [Write] in the upper right corner, and keep the programmer's sensing area close to the NFC logo of the driver, so the parameters can be written to the driver.

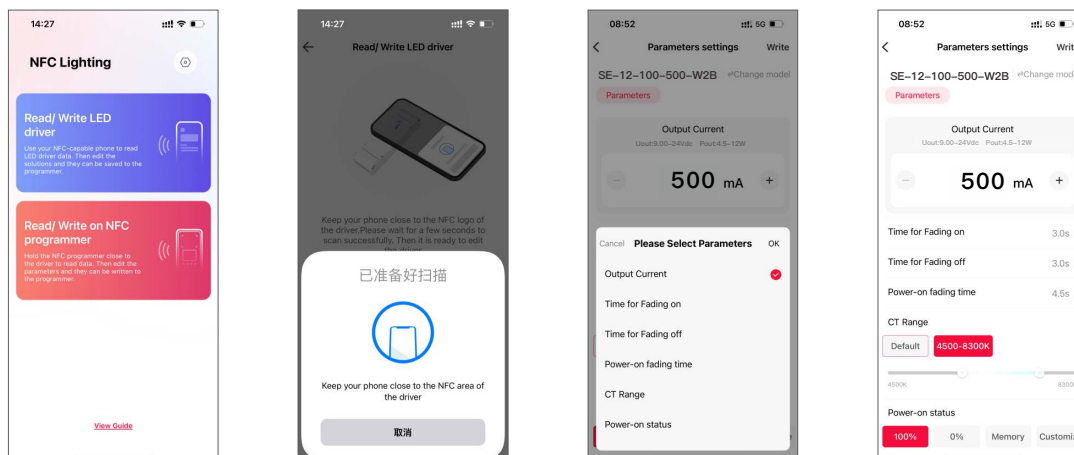

## Bluetooth System Diagram

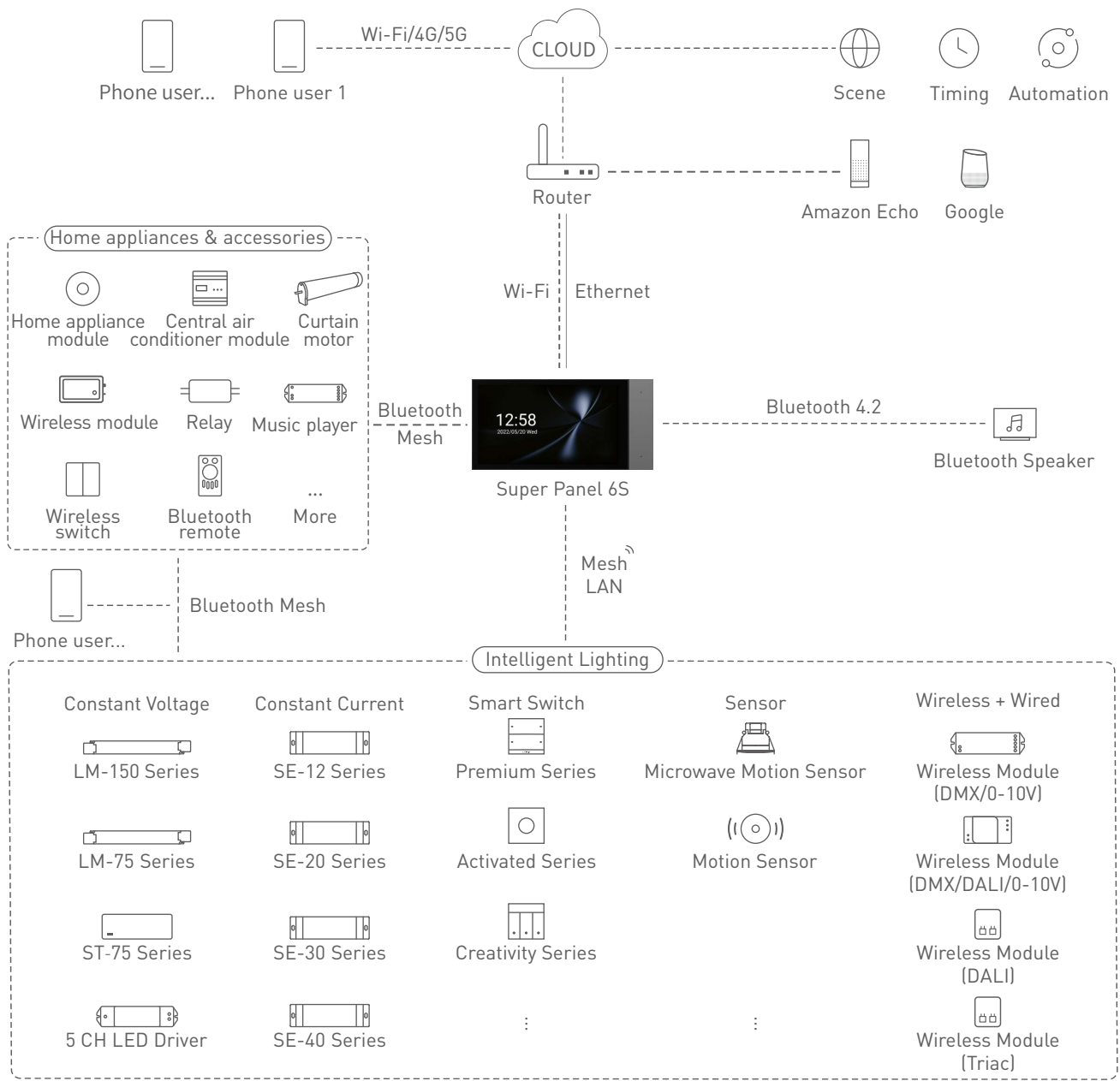

## Recommend Applications

1. Achieve fast dimming control.

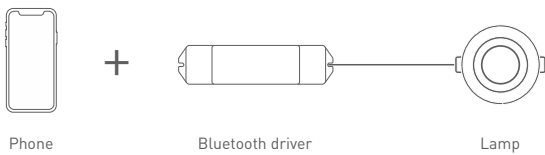

2. Both App and remote can control the driver after connecting the remote to the driver with App.

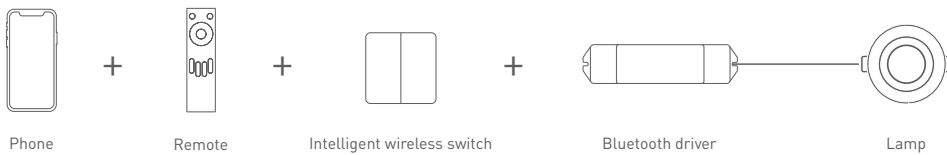

3. Both App and Super Panel 6S can control the driver simultaneously after connecting the Super Panel 6S to the driver with App. By connecting the Super Panel to network, you are allowed to control the driver, cloud scenes and automation remotely with App.

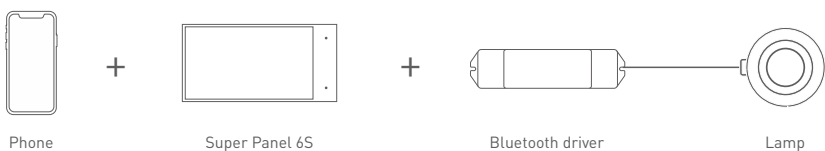

4. ....More applications of intelligent control are waiting for you to set up.

## Use with Bluetooth L-Home APP

### 1. Register an account

The App is available on iOS or Android devices. Scan the QR code below with you mobile phone and follow the prompts to complete the App installation. Open the App to log in or register an account.



### 2. Paring instructions

Open the APP and create a home if you are a new user. Click "+" icon in the upper right corner and access the "Add Device" list, then follow the prompts to add the device. Pick "Smart lighting-CT light" from the list and follow the prompts to power on the device firstly. Make sure the device is not connected to the network. Then click "Bluetooth Search" and follow the prompts to add the device.

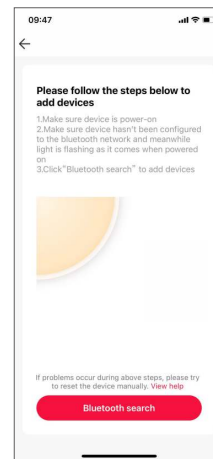
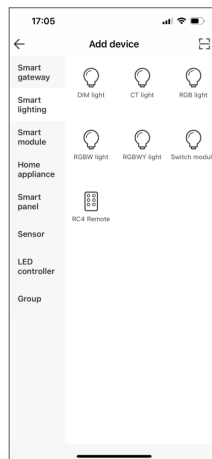
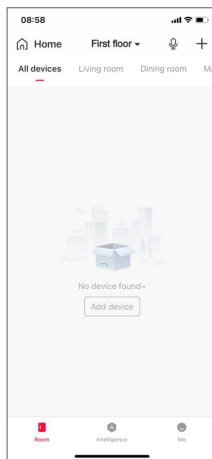

### 3. Control interface settings

After pairing up your device, go to the control interface. You'll be able to achieve your desired lighting effects by changing brightness and color temperature. Click "Theme" and you'll easily switch to multiple theme lighting effects with one tap. Click "Mode" and the App provides you editable advanced modes. Customize dynamic modes to put you into a more colorful life.

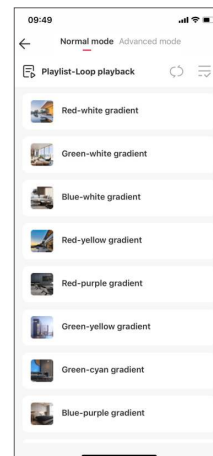
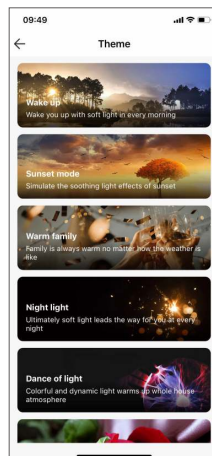
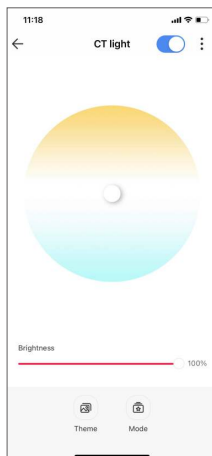

4. Light groups

Users are able to combine the same type of light fixtures into a group to control them simultaneously. Once you create the group, you can set the dim level and adjust the color temperature more easily. Pick "Group-CT light group" from the list. Follow the prompts to rename the group and click "Next" to pick the lights you are going to group together and click "Save".

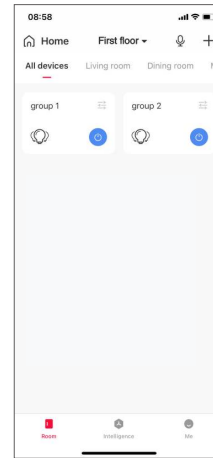
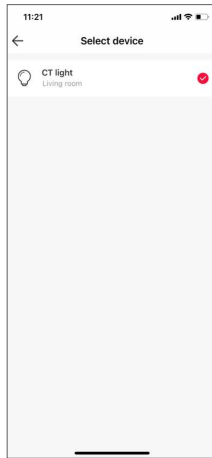
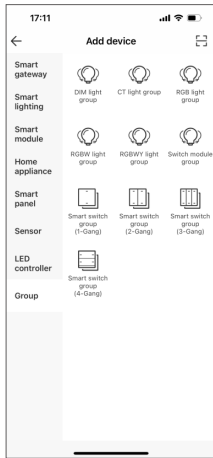

5. Advanced functions

This driver can be linked up with gateway function devices (such as LTECH Super Panel) to achieve the advanced functions from cloud scenes to automation.

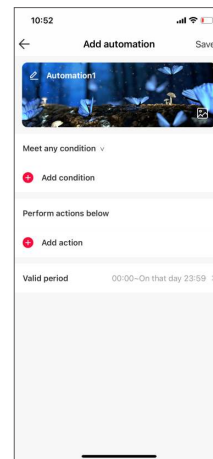
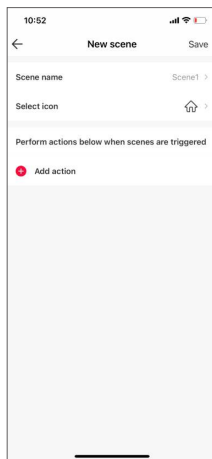
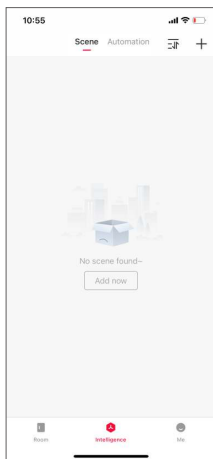

Reset The Device (Reset to factory defaults)

Make sure the driver is well-connected to a lamp and the lamp is on, turn it off with the switch and after 15s turn it on. After 2s, turn it off again. Repeat the same operation 6 times. When the lamp flashes 5 times, reset the device to factory defaults successfully.

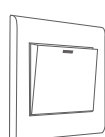

Turn it on 2s  
↑  
Turn it off 15s

Under the driver being power-on

Turn it off — 15s — Turn it on — 2s — .....  
(Repeat 6 times)

## Relationship Diagrams

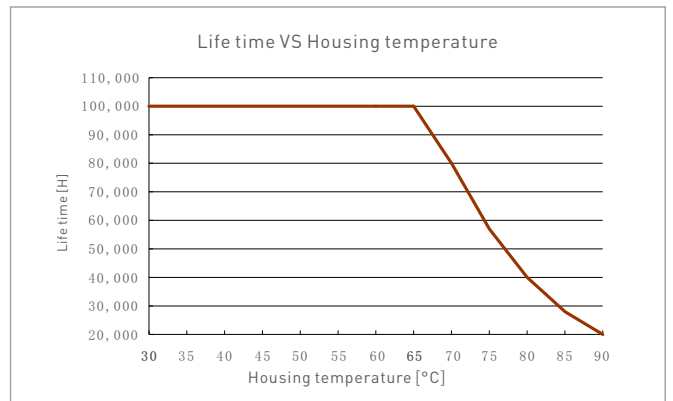
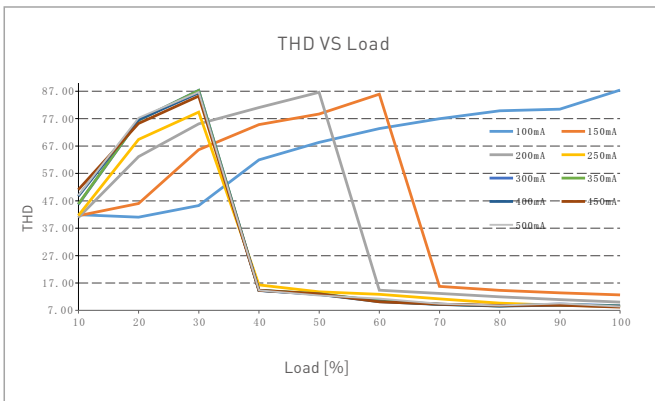
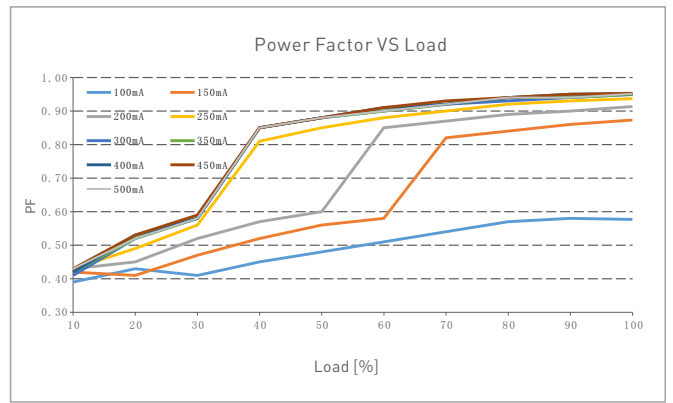
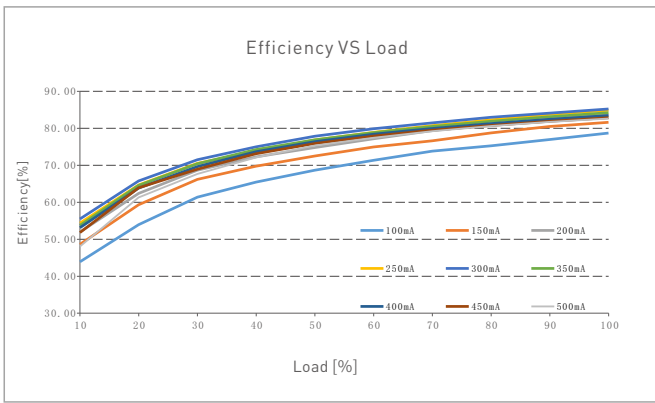

## SE-12-100-500-W2D

## Flicker Test Sheet

Limit of modulation in low risk area	
Waveform frequency of optical output	limit [%]
$f < 8\text{Hz}$	0.2
$8\text{Hz} < f < 90\text{Hz}$	$0.025 \times f$
$90\text{Hz} < f < 1250\text{Hz}$	$0.08 \times f$
$f > 1250\text{Hz}$	Exemption assessment
Limit of modulation in no effect area	
Waveform frequency of optical output	limit [%]
$f < 10\text{Hz}$	0.1
$10\text{Hz} < f < 90\text{Hz}$	$0.01 \times f$
$90\text{Hz} < f < 3125\text{Hz}$	$[0.08/2.5] \times f$
$f > 3125\text{Hz}$	Exemption assessment (High frequency exemption)

### Brightness

- ▲ 0.1%
- ◆ 1%
- ◆ 5%
- ◆ 10%
- 20%
- 30%
- 40%
- ★ 50%
- ★ 60%
- ★ 70%
- ★ 80%
- ★ 90%
- ◆ 100%

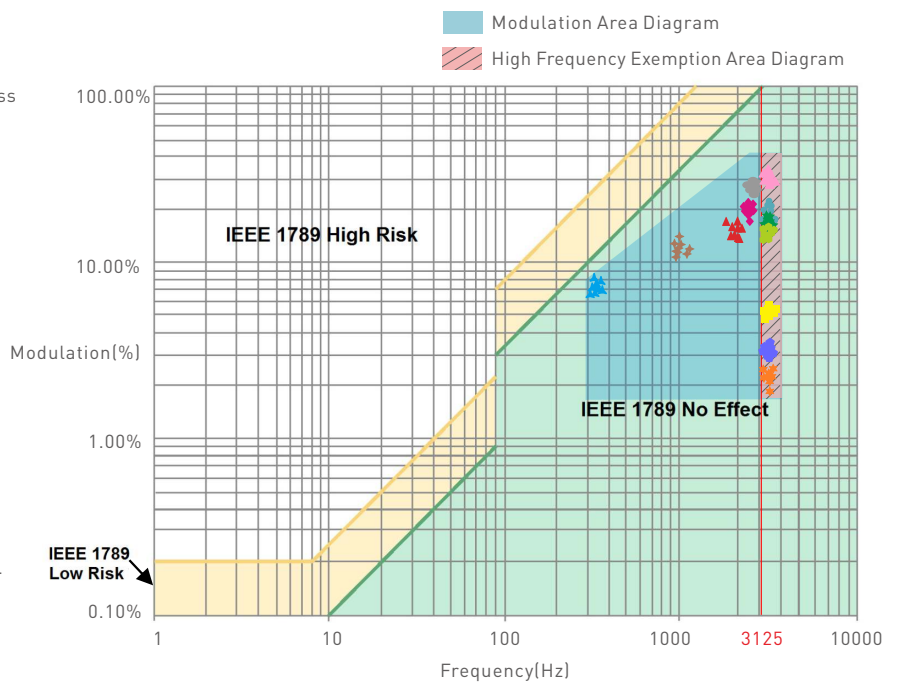

Marks in the right chart were tested results of different current ranges. The output frequency is 0Hz in 100% brightness and its corresponding modulation is 0%, which could not be shown in the right chart.



Packaging Specifications

Model	SE-12-100-500-W2B
Carton Dimensions	260×240×215mm(L×W×H)
Quantity	20 PCS/Layer; 5 Layers/Carton; 100 PCS/Carton
Weight	0.095 kg/PC; 9.5 kg±5%/Carton

Packaging Image



Inner Packaging Box



Carton Packaging

## Transportation and Storage

### 1. Transportation

Products can be shipped via vehicles, boats and planes.

During transportation, products should be protected from rain and sun. Please avoid severe shock and vibration during the loading and unloading process.

### 2. Storage

The storage conditions should comply with the Class I Environmental Standards. The products that have been stored for more than six months are recommended to be re-inspected and can be used only after they have been qualified.

## Attentions

- This product must be installed and adjusted by a qualified professional.
- LTECH products are and not lightningproof non-waterproof (special models excepted). Please avoid the sun and rain. When installed outdoors, please ensure they are mounted in a water proof enclosure or in an area equipped with lightning protection devices .
- Good heat dissipation will extend the life the product. Please install the product in a environment with good ventilation.
- When you install this product, please avoid being near a large area of metal objects or stacking them to prevent signal interference.
- Please keep the product away from a intense magnetic field, a high pressure area or a place where lightning is easy to occur.
- Please check whether the working voltage used complies with the parameter requirements of the product.
- Before you power on the product, please make sure all the wiring is correct in case of incorrect connection that may cause a short circuit and damage the components, or trigger a accident.
- If a fault occurs, please do not attempt to fix the product by yourself. If you have any question, please contact the supplier.

\* This manual is subject to changes without further notice. Product functions depend on the goods. Please feel free to contact our official distributors if you have any question.

## Warranty Agreement

- Warranty periods from the date of delivery: 5 years.
- Free repair or replacement services for quality problems are provided within warranty periods.

Warranty exclusions below:

- Beyond warranty periods.
- Any artificial damage caused by high voltage, overload, or improper operations.
- Products with severe physical damage.
- Damage caused by natural disasters and force majeure.
- Warranty labels and barcodes have been damaged.
- No any contract signed by LTECH.

1. Repair or replacement provided is the only remedy for customers. LTECH is not liable for any incidental or consequential damage unless it is within the law.
2. LTECH has the right to amend or adjust the terms of this warranty, and release in written form shall prevail.

**Update Log**

Version	Updated Time	Update Content	Updated by
A0	20230728	Original version	Yang Weiling