

Intelligent Tunable White LED Driver (Constant Current)

- Housing made of Covestro/Samsung PC flame-retardant V0 raw material, ultra-thin and lightweight, tool-free screwless end cover for easy installation and removal.
- Matter certified device, communicates over IPv6 Thread network and requires a Matter hub with Thread Border Router functionality (such as Apple HomePod mini or Google Nest Hub).
- Supports control via mainstream Matter smart home platforms including Apple Home, Google Home, etc., with voice control support.
- Easy pairing and commissioning via QR code scanning.
- Supports standard Matter OTA updates.
- Supports NFC programming to adjust parameters including output current, dimming fade time, power-on fade time, brightness range, CT range, etc.
- T-PWM ultra-deep dimming technology with dimming depth down to 0.0001%.
- 0-100% full-range dimming with no visible flicker, compliant with high-frequency exemption level.
- Built-in soft start and gradual brightening for more comfortable visual experience.
- EU ERP compliant: no-load power consumption and network standby power consumption < 0.5W.
- No-load protection to prevent LED damage from poor contact.
- Over-temperature, overload and short-circuit protection with automatic recovery.
- Suitable for indoor Class I, II and III lighting applications.
- Service life up to 100,000 hours under normal operation.
- 5-year warranty (equipped with Ruby capacitors).



T-PWM Dimming Technology

Flicker Free IEEE 1789

Dimmable: 1:1000000

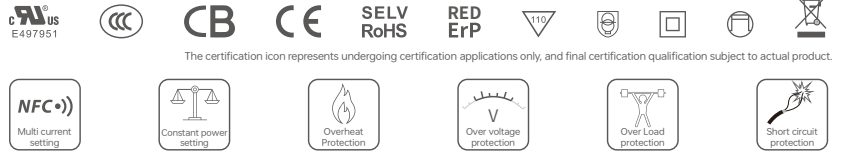
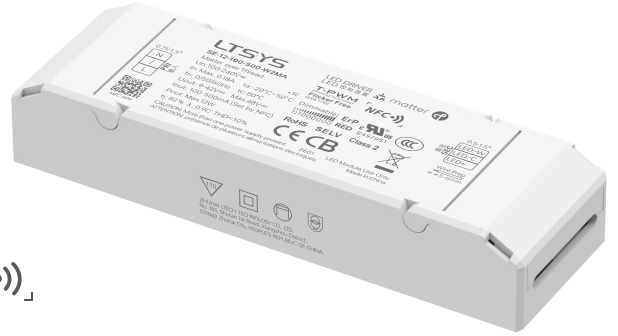

Technical Specs

Model	SE-12-100-500-W2MA			
FEATURES	Output Type	Constant current		
	Dimming Interface	Matter over Thread, Matter 1.4		
	Output Feature	Isolation		
	IP Rating	IP20		
	Insulation Class	Class II (Suitable for class I/II/III light fixtures)		
OUTPUT	Output Voltage	9-42V $\overline{=}$		
	Max. Output Voltage	$\leq 48V \overline{=}$		
	Rated Current Range	100-500mA(Set higher current via mobile APP NFC; step value down to 1mA; Default: 100mA)		
	Load Power Range	0.9W-12W		
	Dimming Range	0-100%, Dimming depth: 0.0001% (Set additional gear ratios via the mobile app's NFC feature,Default:0.01%)		
	LF Current Ripple	<3%(Maximum current for non dimming state)		
	Current Accuracy	$\pm 5\%$		
INPUT	PWM Frequency	$\leq 3600Hz$		
	DC Voltage Range	100-240V $\overline{=}$		
	AC Voltage Range	100-240V \sim		
	DC Current Range	Max.0.18A		
	Rated Voltage	115V \sim /230V \sim		
	Frequency	0/50/60Hz		
	Input Current	$\leq 0.18A/115V \sim, \leq 0.08A/230V \sim$		
	Power Factor	PF>0.95/115V \sim (Fully loaded), PF>0.9C/230V \sim (Fully loaded)		
	THD	THD $\leq 10\%/230V \sim$ (Fully loaded)		
	Efficiency(Typ.)	84%@300mA (Fully loaded) ,82%@500mA (Fully loaded)		
ENVIRONMENT	Inrush Current	Cold start 15A(Test twidth=102us tested under 50% Ipeak)/230V \sim		
	Anti Surge	L-N: 2KV		
	Leakage Current	Max. 0.24mA		
	Operating Temperature	ta: -20 ~ 50°C tc: 80°C		
	Working Humidity	20 ~ 95%RH, non-condensing		
PROTECTION	Storage Temperature/Humidity	-40 ~ 80°C/10~95%RH		
	Temperature Coefficient	$\pm 0.03\%/^{\circ}C(-20-45^{\circ}C)$		
	Vibration	10-500Hz, 2G 12min/1cycle, 72 min for X, Y and Z axes respectively		
	Overload Protection	Automatically protect the device when the load exceeds 102% of the rated power. Automatically recover once load is reduced		
	Overheat Protection	Intelligently adjust or turn off the current output if the PCB temperature $\geq 110^{\circ}C$. When the PCB temperature <90°C, automatically recover normal output		
SAFETY & EMC	Overvoltage Protection	Automatically protect the device when voltage exceeds the no-load voltage. It can be recovered automatically		
	Short Circuit Protection	Enter hiccup mode if short circuit occurs, and recover automatically		
ErP	Withstand Voltage	I/P-O/P: 3750V \sim		
	Insulation Resistance	I/P-O/P: 100M Ω /500VDC/25°C/70%RH		
	Safety Certifications	CCC	China	GB19510.1, GB19510.14, GB19510.213
		CB	CB Member States	IEC61347-1, IEC61347-2-13
		CE	European Union	EN61347-1, EN61347-2-13, EN62384
		CUL	Canada	CSA C22.2 No.250.13
		UL	United States	UL 8750
	EMC Emission	CCC	China	GB/T17743, GB17625.1
		CE	European Union	EN55015, EN61000-3-2, EN61000-3-3, EN61547
		CUL	Canada	ICES-005
UL		United States	FCC part 15B	
EMC Immunity		EN61000-4-2,3,4,5,6,8,11, EN61547		
OTHERS	Power Consumption	Networked standby	< 0.5W(After shutdown by command)	
		No-load power consumption	< 0.5W (When the lamp is not connected)	
	Flicker/Stroboscopic Effect	IEEE 1789	Meet IEEE 1789 standard/High frequency exemption level	
		CIE SVM	Pst LM ≤ 1.0 , SVM ≤ 0.4	
	DF	Phase factor	DF ≥ 0.9	
	Weight(N.W.)	85g \pm 10g		
	Dimensions	110 \times 35 \times 20mm(L \times W \times H)		

Typical Current Corresponding Parameter Table

The following 9 groups of typical current data are provided for model selection reference. More currents can be set via the mobile phone APP NFC.
The settable range is 100-500mA, and the current step value can be as low as 1mA.

Output Current	100mA	150mA	200mA	250mA	300mA
Output Voltage	9-42Vdc	9-42Vdc	9-42Vdc	9-42Vdc	9-40Vdc
Output Power	0.9-4.2W	1.35-6.3W	1.8-8.4W	2.25-10.5W	2.7-12W
Output Current	350mA	400mA	450mA	500mA	/
Output Voltage	9-34Vdc	9-30Vdc	9-27Vdc	9-24Vdc	/
Output Power	3.15-11.9W	3.6-12W	4.05-12.15W	4.5-12W	/

Product Size

Unit: mm

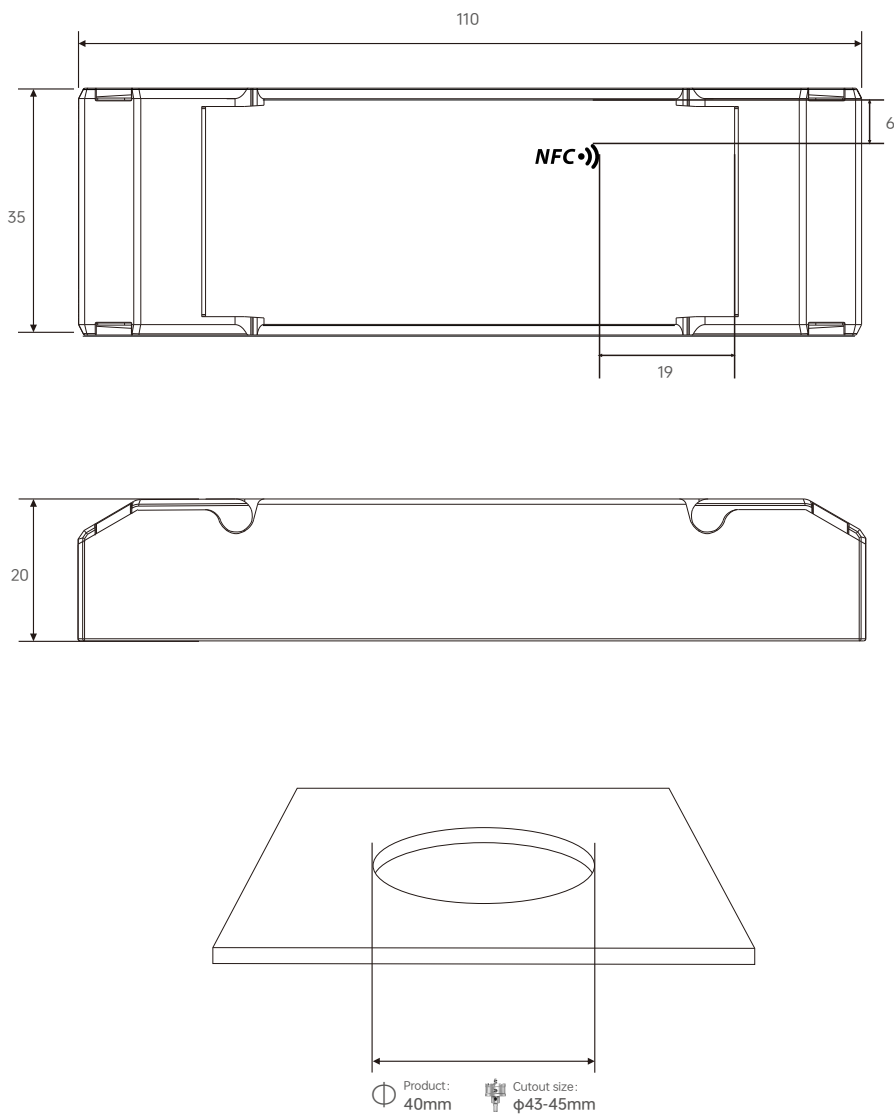

Connectivity Diagram

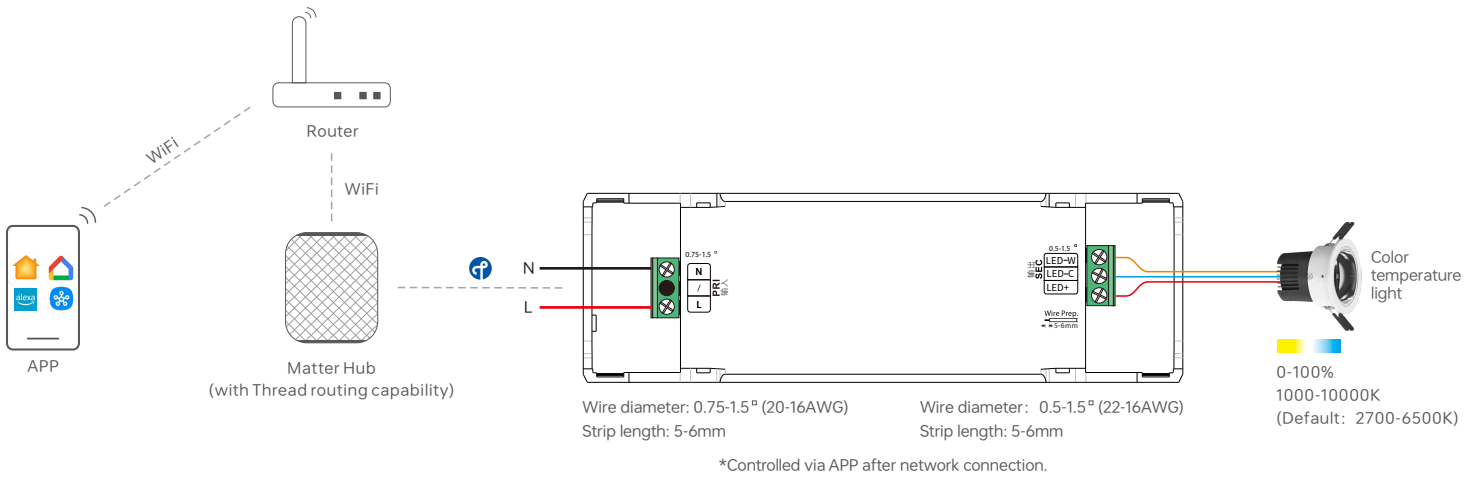

Application Diagram of Protective Cover

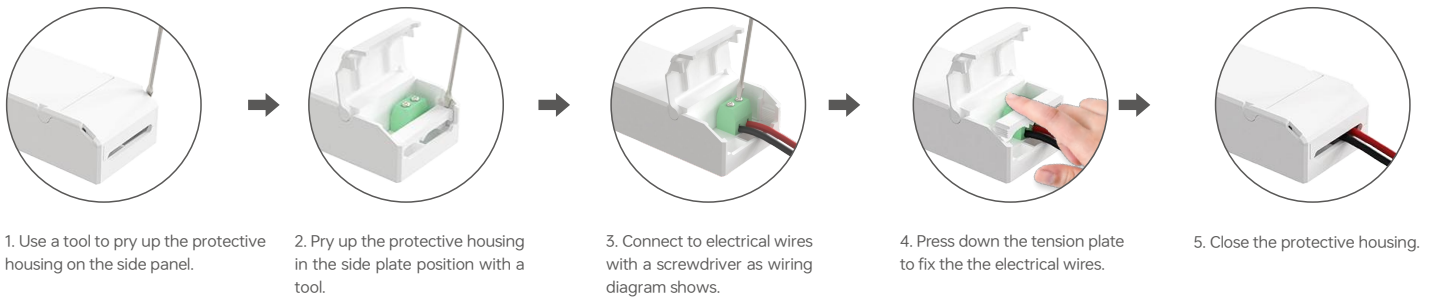

Installation Precautions

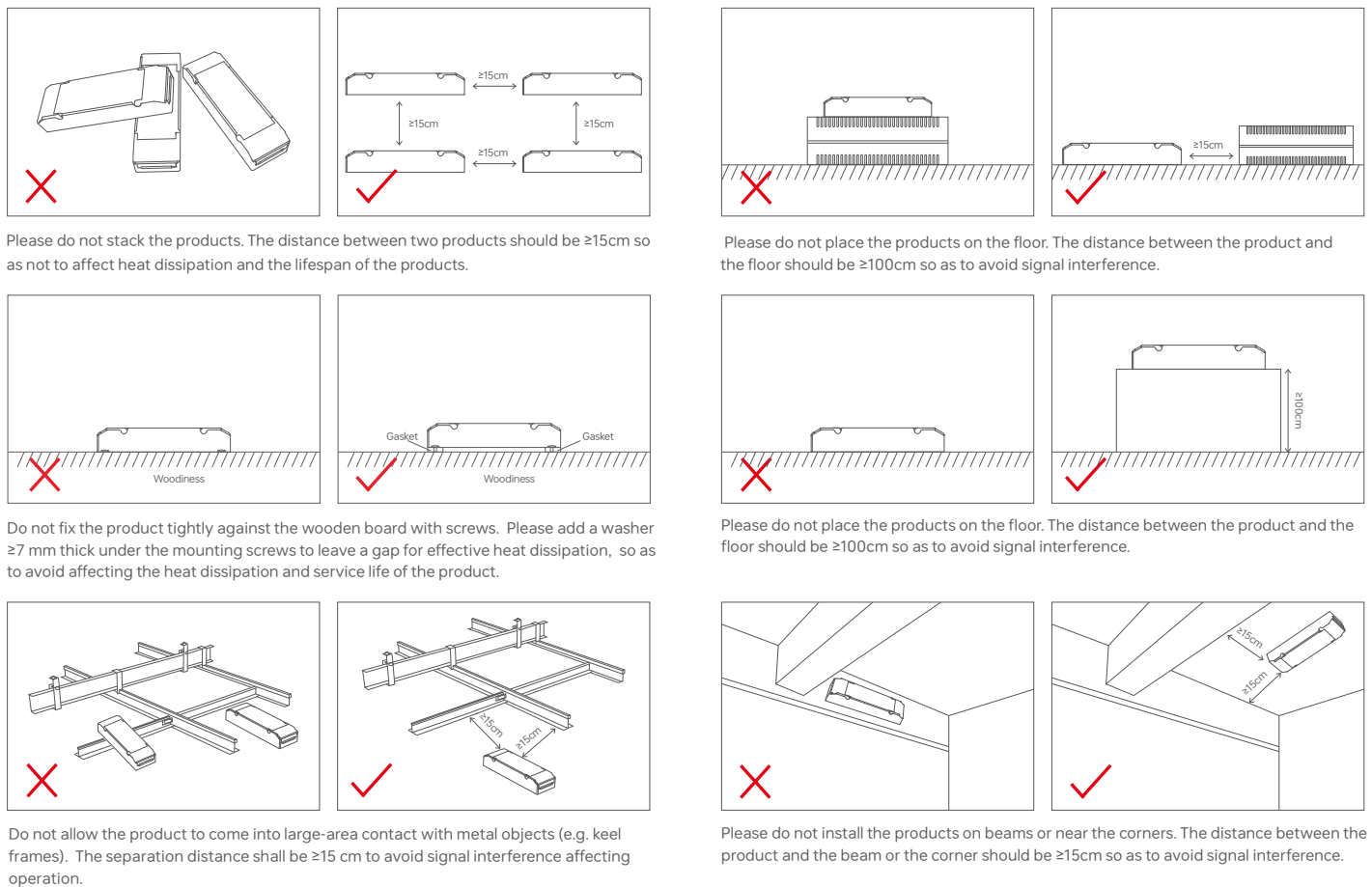

Relationship Diagrams

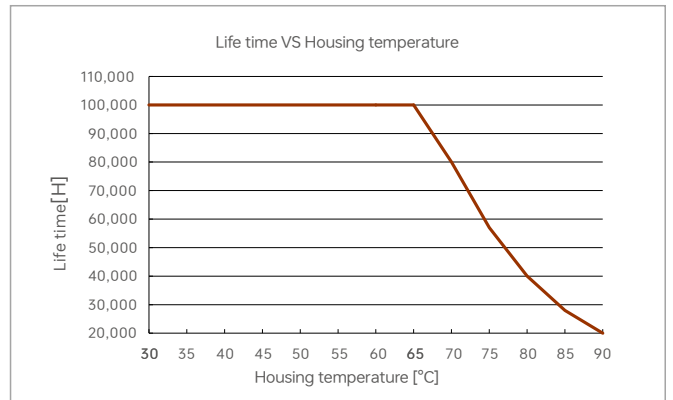
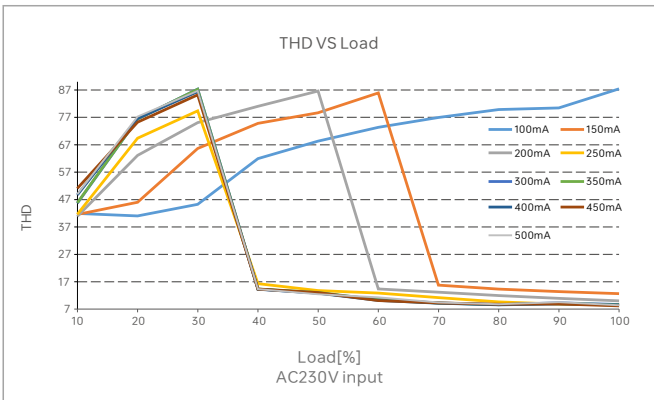
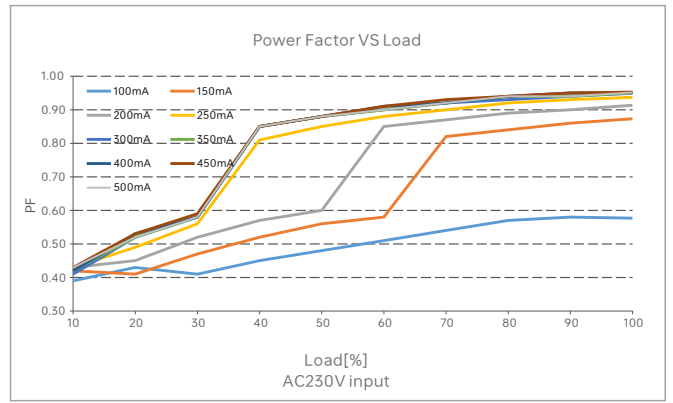
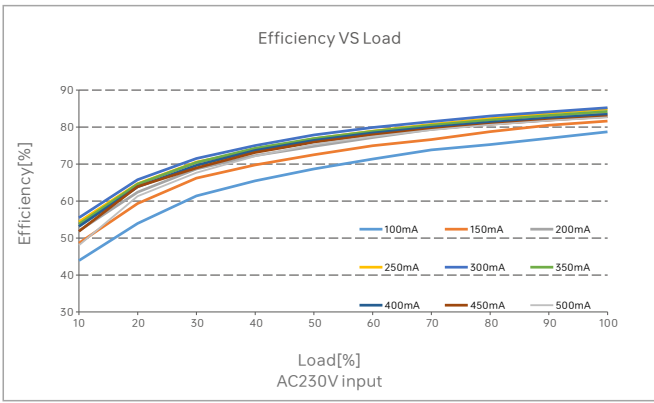

SE-12-100-500-W2MA

Flicker Test Sheet

IEEE 1789

Limit of modulation in low risk area	
Waveform frequency of optical output	limit (%)
$f \leq 8\text{Hz}$	0.2
$8\text{Hz} < f \leq 90\text{Hz}$	$0.025 \times f$
$90\text{Hz} < f \leq 1250\text{Hz}$	$0.08 \times f$
$f > 1250\text{Hz}$	Exemption assessment
Limit of modulation in no effect area	
Waveform frequency of optical output	limit (%)
$f \leq 10\text{Hz}$	0.1
$10\text{Hz} < f \leq 90\text{Hz}$	$0.01 \times f$
$90\text{Hz} < f \leq 3125\text{Hz}$	$(0.08/2.5) \times f$
$f > 3125\text{Hz}$	Exemption assessment (High frequency exemption)

Brightness

- ▲ 0.1%
- ◆ 1%
- ▲ 5%
- ◆ 10%
- 20%
- ▲ 30%
- 40%
- ★ 50%
- 60%
- 70%
- ◆ 80%
- ★ 90%
- ◆ 100%

Modulation Area Diagram

High Frequency Exemption Area Diagram

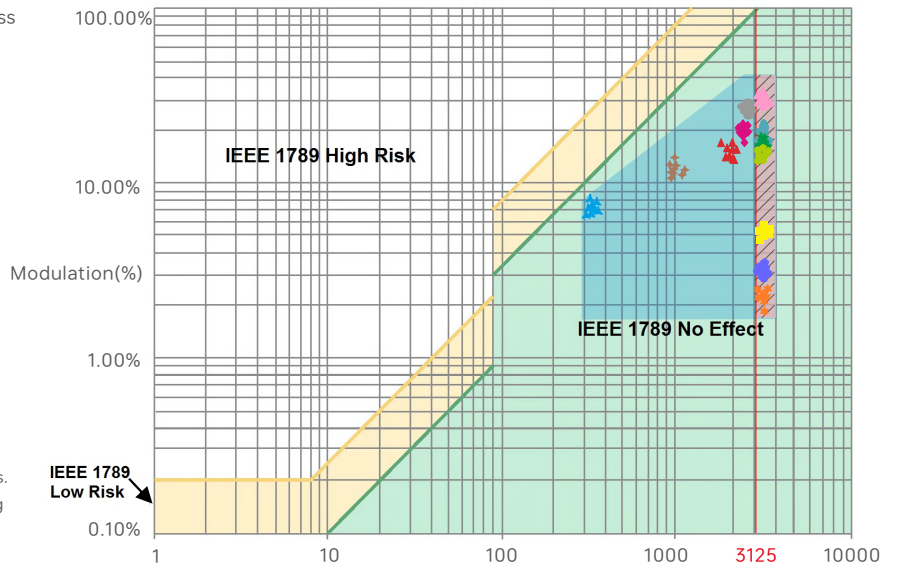

Marks in the right chart were tested results of different current ranges. The output frequency is 0Hz in 100% brightness and its corresponding modulation is 0%, which could not be shown in the right chart.

Add to Matter Platform Instructions

1. This device supports control via major smart home platforms, including Apple Home, Amazon Alexa, Google Home, SmartThings, and others.
2. To connect Matter over Thread devices, you need a Matter hub supporting Thread border router functionality from major platforms. Refer to the image below for compatible models.

 Apple Home	 SmartThings	 Google Home	 Amazon Alexa
Apple HomePod (second-gen)	Aeotec SmartThings Smart Home Hub	Google Nest Hub (2nd Gen)	Amazon Echo (4th-gen)
Apple HomePod Mini	Samsung SmartThings Station	Google Nest Hub Max	Amazon Echo Hub
Apple TV 4K (2nd gen)	Samsung SmartThings Hub Dongle	Google Nest Wifi Pro	Amazon Echo Show 8 (3rd-gen)
Apple TV 4K (3rd gen, 128 GB)	Samsung SmartThings Hub v3	Google TV Streamer (4K)	Amazon Eero 6, Pro 6, 6 Plus, Max 7 etc.

3. This guide uses Apple Home as an example. First, prepare an iPhone (iOS 16.2 or later) or iPad (iPadOS 16.2 or later) with the latest firmware, along with an Apple HomePod mini also running the latest firmware. Then connect your iPhone or iPad to your home Wi-Fi network, launch the Apple Home app, and follow Apple's instructions to set up the HomePod mini.

*For iPhone models 16 and above, no Matter hub is required; devices can be added directly.

Adding Steps (Using Apple Home as an Example)

1.Add Accessory

Open the Apple Home app, tap Add or Scan Accessory, and add the device to the Home app by scanning the QR code label on the device, as shown below.

*Alternatively, add via NFC: Open the Home app, bring it close to the device's NFC sensing area for recognition and network connection.

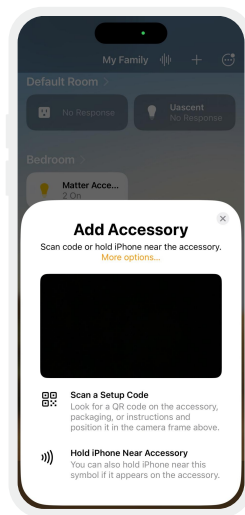
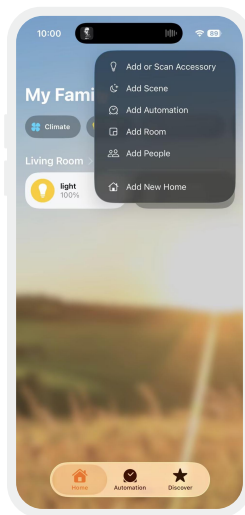

2.Control the Device

After the device has been successfully added, tap the device icon to turn it ON/OFF; tap the device card to enter the brightness and color temperature control interface.

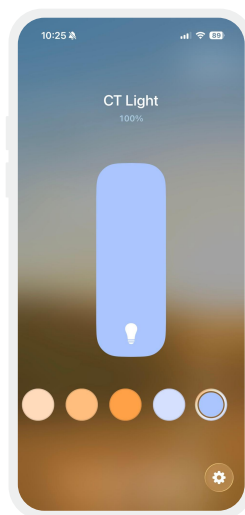
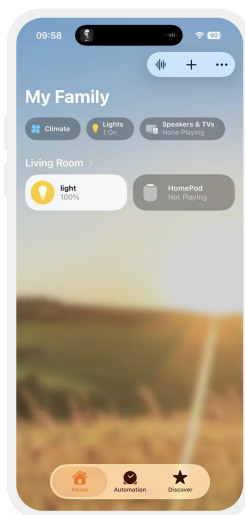

3. Advanced Functions

Supports creating groups, scenes, automation, remote control and timer control. The device can also be controlled via Siri voice commands.

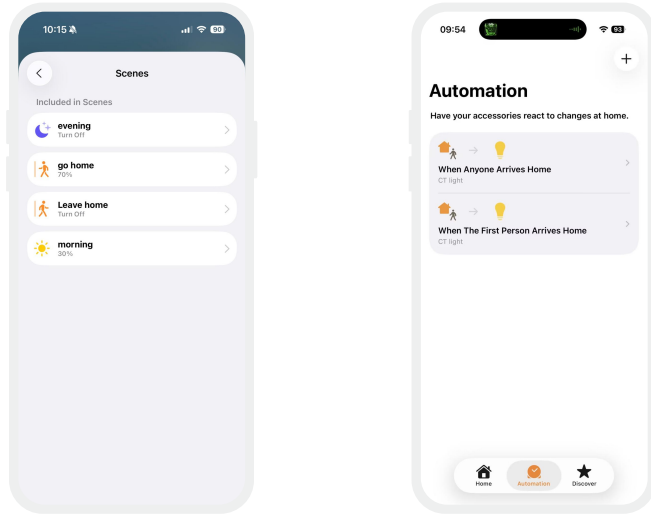

4. Multi-Ecosystem Network Configuration

If the product needs to be added to two or more ecosystems, you may go to the device settings page, tap Enable Pairing Mode, obtain the pairing code, and add it to third-party platforms.

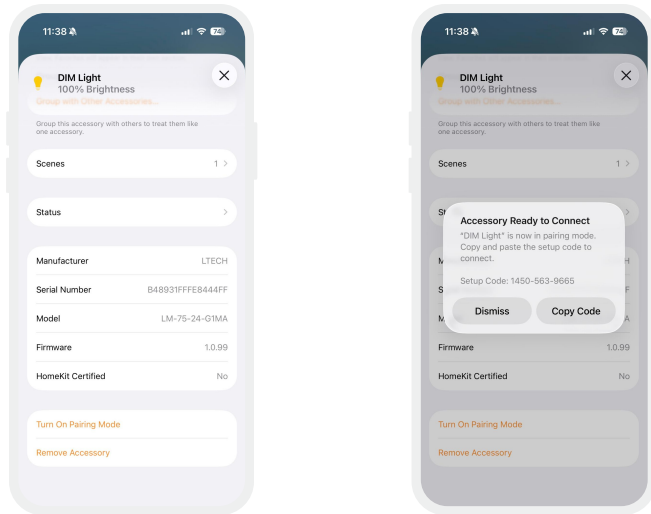

Reset to the defaults

Ensure the device is connected to the light and the light stays on steadily. Turn the power off and on 6 times in a row using the switch: (Turn off for 15 seconds, Turn on for 2 seconds) After the 6th time you turn it on (leave it on for 2 seconds), the light will flash 5 times. This means the device has been successfully restored to factory settings.

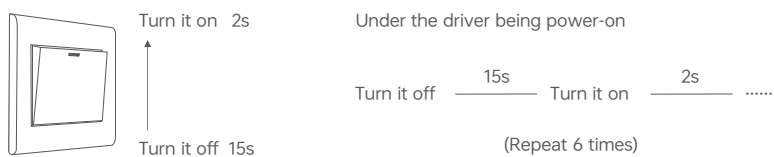

Use the NFC Lighting APP

Scan the QR code below with your mobile phone and follow the prompts to complete the APP installation (According to performance requirements, you need to use a NFC-capable Android phone, or an iPhone 8 and later that are compatible with iOS 13 or higher).



* Before you begin setting the parameters of the driver, please make sure the driver is powered off .

Read/Write the LED driver

Use your NFC-capable phone to read LED driver data, then edit the parameters and they can be directly written to the driver.

1. Read the LED driver

On the APP home page, click **【Read/Write LED driver】** , then keep the programmer's sensing area close to the NFC sensing area of the driver to read the driver parameters.

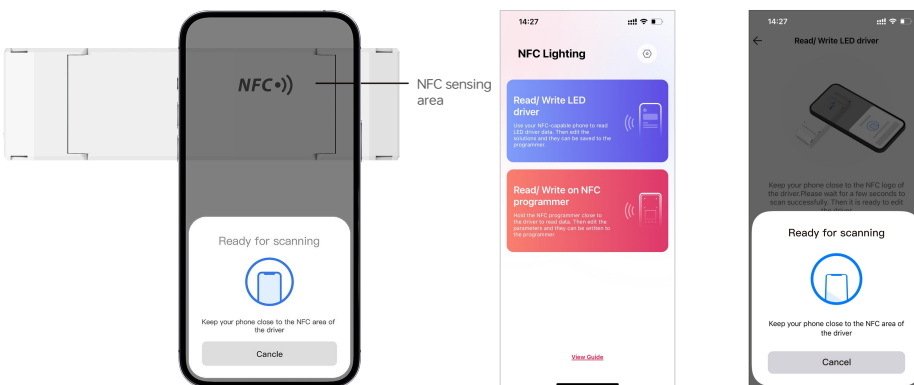

2. Edit the parameters

Click **【Parameter settings】** to edit more advanced parameters such as output current, dimming fade time, power-on fade time, Dimming Depth, brightness range, CT range, power-on state.

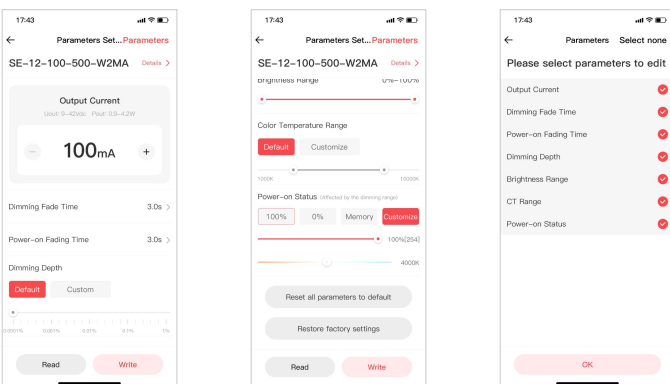

3. Write to the driver

After completing the parameter settings, click **【Write】** in the upper right corner, and keep the programmer's sensing area close to the NFC sensing area of the driver, so the parameters can be written to the driver.

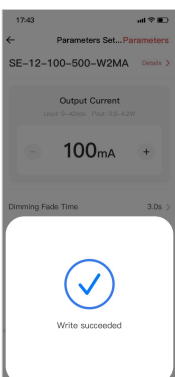

Packaging Specifications

Model	SE-12-100-500-W2MA
Carton Dimensions	260×240×215mm(L×W×H)
Quantity	20 PCS/Layer; 5 Layers/Carton; 100 PCS/Carton
Weight	0.095kg/PC; 9.5 kg±5%/Carton

Packaging Image

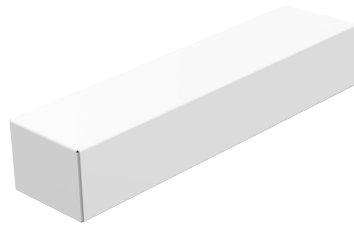

Inner Packaging Box



Carton Packaging

FAQ

This product is designed in compliance with the Matter protocol standard. As the protocol is still in the early stage of industry development and limited by the current version, some functions, performance and network connection stability may be subject to further optimization. Product performance is subject to the current version of the Matter protocol. Our company will continuously upgrade and optimize product functions and performance in line with official updates. Please kindly note.

1. What should I do if the large number of Matter devices managed by the Matter hub gateway causes unstable connections and control?
 - 1.1 It is recommended that each hub gateway add no more than 40 Matter devices.
 - 1.2 It is recommended that the hub gateway remain powered on at all times; otherwise, the device reconnection time will be long.
 - 1.3 Routers of different brands and performances have a certain impact on the number of devices managed by the Matter hub. It is recommended to choose a high-performance router.

2. What should I do if packet loss occurs during group control switching or dimming, and the app status flips back and forth?

It is recommended to keep the number of devices in a group within 10 units.

3. What should I do if the device goes offline and cannot recover after a long period of inactivity?

It is recommended to power the device off and on again to reconnect.

4. What should I do if adding the device still fails after restoring it to factory settings?

Please try powering the device off and on again before adding it.

5. Common reasons for failed device addition caused by router issues.
 - 5.1 The router must have the IPv6 option enabled.
 - 5.2 The router must have the "Brute-force network attack prevention" option disabled.
 - 5.3 Do not connect to the guest Wi-Fi; connect to the main Wi-Fi network instead.

Transportation and Storage

1. Transportation

Products can be shipped via vehicles, boats and planes.

During transportation, products should be protected from rain and sun. Please avoid severe shock and vibration during the loading and unloading process.

2. Storage

The storage conditions should comply with the Class I Environmental Standards. The products that have been stored for more than six months are recommended to be re-inspected and can be used only after they have been qualified.

Attentions

- Products shall be installed by qualified professionals.
 - LTECH products are and not lightningproof non-waterproof (special models excepted). Please avoid the sun and rain. When installed outdoors, please ensure they are mounted in a water proof enclosure or in an area equipped with lightning protection devices.
 - Good heat dissipation will prolong the working life of products. Please ensure good ventilation.
 - Please check if the working voltage used complies with the parameter requirements of products.
 - The diameter of wire used must be able to load the light fixtures you connect and ensure the firm wiring.
 - Before you power on products, please make sure all the wiring is correct in case of incorrect connection that causes damage to light fixtures.
 - If a fault occurs, please do not attempt to fix products by yourself. If you have any question, please contact your suppliers.
- * This manual is subject to changes without further notice. Product functions depend on the goods. Please feel free to contact our official distributors if you have any question.

Warranty Agreement

- Warranty periods from the date of delivery: 5 years.
- Free repair or replacement services for quality problems are provided within warranty periods.

Warranty exclusions below:

- Beyond warranty periods.
- Any artificial damage caused by high voltage, overload, or improper operations.
- Products with severe physical damage.
- Damage caused by natural disasters and force majeure.
- Warranty labels and barcodes have been damaged.
- No any contract signed by LTECH.

1. Repair or replacement provided is the only remedy for customers. LTECH is not liable for any incidental or consequential damage unless it is within the law.
2. LTECH has the right to amend or adjust the terms of this warranty, and release in written form shall prevail.