

# Full-Color Knob Panel

Model: E6M



Manual

# Product Introduction

- The modern design with innovative multicolor indicators enables intuitive and visible smart interaction.
- DMX and Bluetooth two-in-one knob controller, standard DMX512 and Bluetooth 5.0 SIG Mesh protocol.
- Supports switching between five DMX control types: dimming, color temperature, RGB, RGBW, and RGBCW.
- Initial address and scene actions can be configured via NFC.
- Compatible with Bluetooth remote controllers B1, B2, B5, B8, and RC4-BLE.
- Supports integration with L-Home smart home system and app for local scene control and automation.
- Works with smart gateways to enable integration with HomeKit, Siri, Google Assistant, Amazon Alexa.

# Specification Parameters

Model	E6M
Output Signal	DMX512
Rated Parameters	100-240V~, 50/60Hz
Control Type	DIM, CT, RGB, RGBW, RGBCW
Wireless Type	Bluetooth 5.0 SIG Mesh
Compatible remote	B1、B2、B5、B8、RC4-BLE
Compatible Driver	DMX driver, DMX decoder
Compatible APP	L-Home、NFC Lighting
Working Temperature	-25°C~50°C
Dimensions	86×86×52mm (L×W×H)
Package Size	102×102×73mm (L×W×H)
Product Weight	130g

# Product Size

Unit: mm

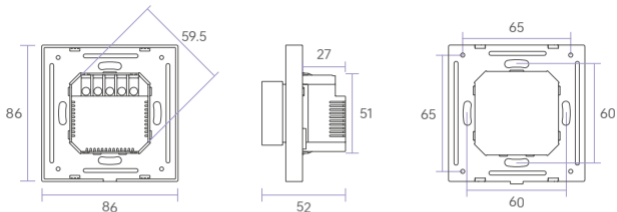

# Product Function Description

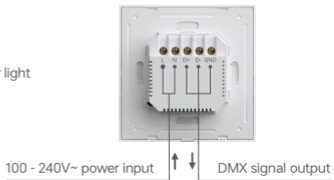
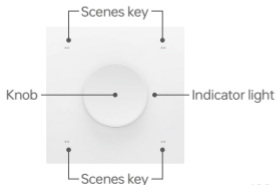

**Scene Buttons:** The scene buttons are factory preset to RGBCW mode. By default, the lighting colors are set to pink for button 1, purple for button 2, cyan for button 3, and white for button 4. Single-clicking any of these buttons will trigger the corresponding scene. To assign specific scene actions, use the L-Home APP via Bluetooth or the NFC Lighting APP via NFC.

**Rotary Knob:** The rotary knob supports single-click, double-click, long-press, and rotation. Sensitivity levels can be adjusted to high, medium, or low to suit different user preferences.

**Indicator Light:** The indicator light changes color based on the current adjustment mode of the rotary knob. It shows white when adjusting brightness (BRT/W), yellow for color temperature (CT/CW), and purple when in RGB mode. The default color is white.

**Factory Reset:** To restore factory settings, press and hold the rotary knob for 15 seconds until the indicator light begins to flash slowly, then release. Within 3 seconds, short-press the knob three times. The indicator will flash quickly, indicating that the reset was successful.

**Introduction to the use of the knob:**



Single Press



Double Press



Rotate



Long Press

Note: Different operations are available depending on the configuration type of the knob.

Device \ Action	Single Press	Double Press	Rotate	Long Press
DIM light	ON/OFF	No action	Adjust BRT	Adjust BRT
CT light	ON/OFF	Switch mode: BRT/CT	Adjust current mode: BRT/CT	Adjust BRT
RGB light	ON/OFF	Switch mode: BRT/RGB	Adjust current mode: BRT/RGB color	Adjust BRT
RGBW light	ON/OFF	Switch mode: RGBW BRT/RGB/W	Adjust current mode: RGBW BRT/RGB color/W	Adjust BRT in current mode: RGBW/RGB/W
RGBCW light	ON/OFF	Switch mode: RGBCW BRT/RGB/CW	Adjust current mode: RGBCW BRT/RGB color/ CW color	Adjust BRT in current mode: RGBCW/RGB/CW

# Installation Steps

① Turn off the main power switch, and confirm that there are no attachments such as cement on the inner wall of the 86 junction box. Trim the length of the power cord inside the junction box to about 10 cm. Use a flat-blade screwdriver to pry open the bottom box of the knob panel, and find the NFC sensing area on the plastic part.



② Use your mobile phone to open the NFC Lighting APP, click [Read/Write Smart Device] on the "Home Page", bring the mobile phone sensing area close to the knob panel NFC sensing area, read the knob panel parameters, set the parameters according to your needs (see P8 for details), click [Write] in the upper right corner, and then bring the mobile phone sensing area close to the knob panel NFC sensing area, and you can directly write to the knob panel.



③ As shown in Figure 1, after reading and writing parameters via NFC, connect the live wire to the L terminal and the neutral wire to the N terminal of the smart switch. Ensure the power wires are securely connected to the terminals, with no exposed copper. (The front-end protection device for the electronic switch must not exceed 35A.) As shown in Figure 2, use screws to fix the base box into the wall-mounted 86 box, making sure the base sits flush against the wall.



Figure 1



Figure 2

④ Tilt the panel and snap it onto the base box. Turn on the main power switch. Press the rotary panel, if the lighting can be controlled normally, the installation is successful.



Step 1: Snap the panel in from the top.

Step 2: Press to secure the bottom.

# Schematic Diagram Of DMX Application

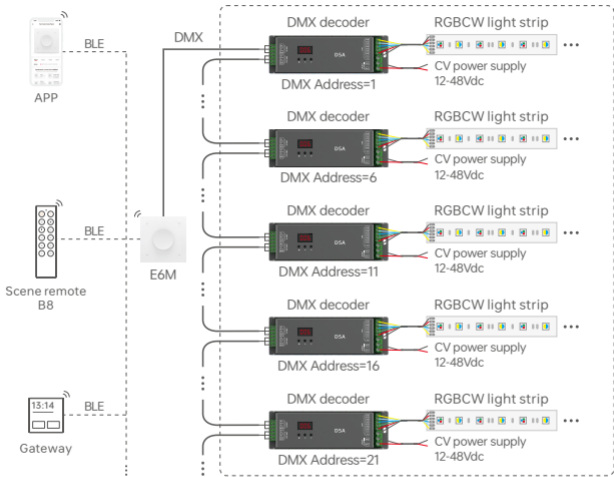

\* If there are more than 32 DMX decoders connected, a DMX signal amplifier should be added, and the signal amplification should not be continuous for more than 5 times. When there are more than 32 DMX/RDM decoders connected, if it is necessary to modify their parameter settings, one RDM signal amplifier can be added, or after the parameter settings are completed, 1 to 5 DMX signal amplifiers can be added.

\* When the signal wire is too long or the wire quality causes signal reflection that affects performance, try connecting a 0.25W 90-120Ω terminating resistor at the end of each signal line to resolve the issue.

# DMX Channel Output Table

Type Address	DIM	CT	CT2	RGB	RGBW	RGBCW
1	DIM	C	BRT	R	R	R
2	DIM	W	CT	G	G	G
3	DIM	C	BRT	B	B	B
4	DIM	W	CT	R	W	C
5	DIM	C	BRT	G	R	W
6	DIM	W	CT	B	G	R
7	DIM	C	BRT	R	B	G
8	DIM	W	CT	G	W	B
9	DIM	C	BRT	B	R	C
10	DIM	W	CT	R	G	W
11	DIM	C	BRT	G	B	R
12	DIM	W	CT	B	W	G
13	DIM	C	BRT	R	R	B
14	DIM	W	CT	G	G	C
⋮	⋮	⋮	⋮	⋮	⋮	⋮
500	DIM	W	CT	G	W	W
⋮	⋮	⋮	⋮	⋮	⋮	/
512	DIM	W	CT	G	W	/

\* Refer to the illustration above, and apply similarly for the following.

# Use with NFC Lighting APP

## 1. Register an account

Scan and download the QR code through your mobile phone, and follow the prompts to complete the APP installation and log in/register. (Due to performance requirements, the phone model is required for Apple: iPhone 8 and above, and operating system iOS 13 and above; Android: NFC-functional model)



\* Device parameters must be set while the device is powered off.

## 2. Read/write knob panel

Click [Read/Write Smart Device] on the "Homepage" of the APP, and bring the phone's sensing area close to the NFC marking of the knob panel (Figure P4) to read the knob panel parameters.

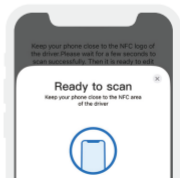

### 3.How to set control type and parameters

**Control type:** Tap "Control Type" to select DIM/CT/RGB/RGBW/RGBCW, default RGBCW.

**Control Start Address:** Tap "Control Start Address" to set the device's start address.

**Parameters Management:** Tap "Parameters" to edit advanced settings such as knob sensitivity, double-click on the mode sort, double-click mode memory, indicator lights, key press sound, scene key, powered on state, and more.

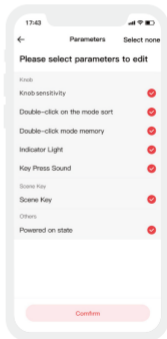
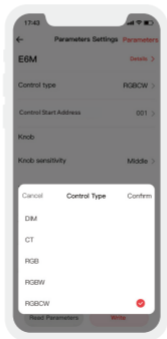
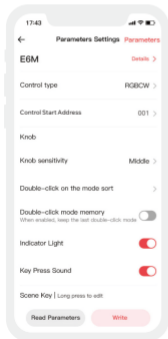

## 4. Rotary Knob and Scene Button Settings

**Rotary Knob:** Tap "Knob sensitivity" to select low, medium, or high sensitivity. Tap "Double-click on the mode sort" to adjust the sequence of total brightness, RGB mode, and W mode (RGBW) / CW mode (RGBCW) when double-clicking the knob. ; Enable or disable double-click mode memory (default is off). Enable or disable the indicator light (default is on). Enable or disable key press sound (default is on).

**Scene key:** Long-press a scene button to bind and execute an action.

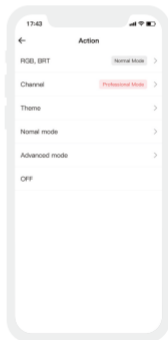
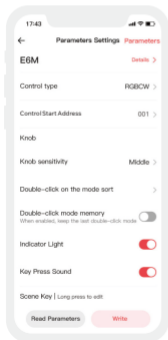

## 5. Powered on state and factory reset settings

**Powered on state:** Options include full bright, light is off, memorize, custom. The default setting is memorize.

**Factory Reset:** After tapping the "All parameters are restored to factory default" button, all parameters on the APP page will revert to factory defaults. Then, tap the "Write" button to upload the parameters to the device, restoring it to factory settings.

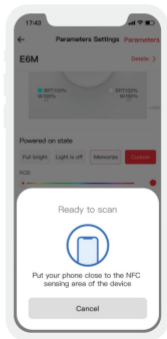
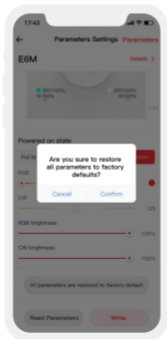
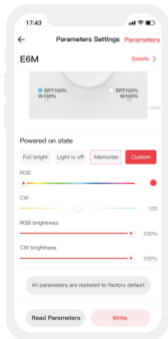

# For Use With The L - Home APP

## 1. Register an account

Scan the QR code below with your mobile phone. After completing the APP installation according to the prompts, you can proceed with the login/registration operation.



## 2. Pairing operation

For new users, after creating a home on the APP, click the "+" icon in the upper right corner on the [Room] interface for addition. Select "LED Controller" from the device addition list, and follow the prompts on the installation interface to complete the addition.

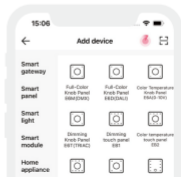
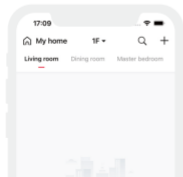

### 3.How to set knobs and scene keys

Click the added knob panel in the "room" interface to enter the [Control] interface.

Knob: Support clicking the knob to enter the page to adjust the light.

Scene key: Each key supports binding different actions.

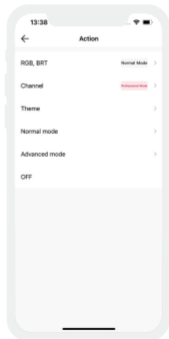
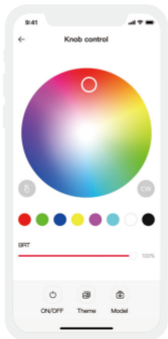
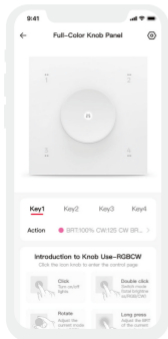

#### 4. Bound by remote control

The rotary panel can be bound as a fixture to B1, B2, B5, B8, or RC4-BLE remote controllers. Each zone on the remote controller supports binding to one rotary panel. Once bound, the remote controller zone will control the load of the rotary panel.

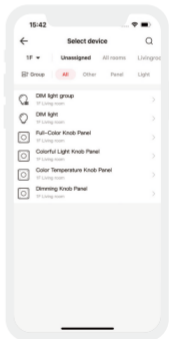
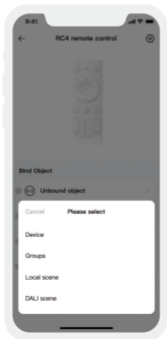
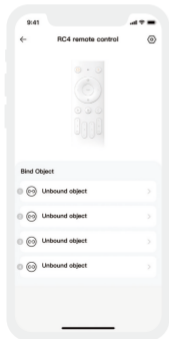

## 5. How to set scenes and automation

**Local Scene:** In the "Intelligence" interface, select "Local Scene" and tap the "+" button to create a local scene. Tap "Add Action" and choose the corresponding device type action.

**Cloud Scene:** Ensure a smart gateway, such as the Super Panel 12S, is added to your home network. In the "Intelligence" interface, select "Cloud Scene" and tap the "+" button to create a cloud scene. Tap "Add Action" and choose the corresponding device type action.

**Automation:** Ensure a smart gateway, such as the Super Panel 12S, is added to your home network. In the "Intelligence" interface, select "Automation" and tap the "+" button to create an automation. You can choose local or cloud execution modes and set trigger conditions and actions. When the trigger conditions are met, a series of device actions will be automatically executed to achieve remote linkage.

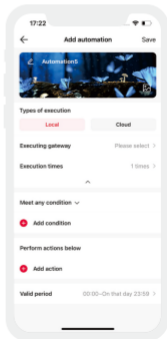
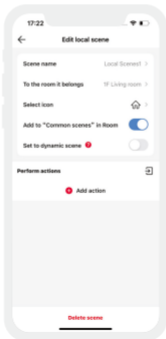
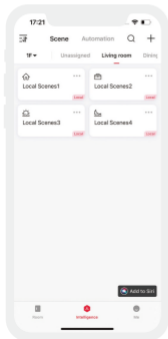

# Restore To Factory Settings

**Method 1:** After the E6M knob panel is connected to power, press the knob for 15 seconds (see Figure 1) until the indicator light flashes slowly and then releases. Press the knob for a short time 3 times within 3 seconds, and the indicator light flashes quickly, indicating that it has returned to the factory settings.

**Method 2:** First, make sure that the device is properly powered on and in an online state. Then, open the L - Home APP, find the device, and enter its settings page. Click the "Delete Device" button (see Figure 2). When the system prompts "Deletion successful", it means that the device has been successfully restored to its factory settings.



Figure 1

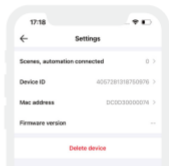

Figure 2

## FAQs

### 1. What to do if the network configuration fails?

- ① Ensure that the device is powered on normally.
- ② Confirm that the device being added has not been added by another account. If it has been added, please manually restore the factory settings.
- ③ Ensure that the mobile phone and the device are as close as possible, preferably within 15 meters.
- ④ If the device has been forcibly deleted, please manually restore the factory settings and then add the device again.

### 2. How to remotely control the device?

When paired with our company's Smart gateway, the device can be remotely controlled via 4G/5G/WiFi on a mobile phone.

# FCC Statement

1. This device complies with Part 15 of the FCC Rules. Operation is subject to the following two conditions:

(1) This device may not cause harmful interference.

(2) This device must accept any interference received, including interference that may cause undesired operation.

2. Changes or modifications not expressly approved by the party responsible for compliance could void the user's authority to operate the equipment.

Note: This equipment has been tested and found to comply with the limits for a class B digital device, pursuant to Part 15 of the FCC Rules. These limits are designed to provide reasonable protection against harmful interference in a residential installation.

This equipment generates uses and can radiate radio frequency energy and, if not installed and used in accordance with the instructions, may cause harmful interference to radio communications. However, there is no guarantee that interference will not occur in a particular installation. If this equipment does cause harmful interference to radio or television reception, which can be determined by turning the equipment off and on, the user is encouraged to try to correct the interference by one or more of the following measures:

- Reorient or relocate the receiving antenna.
- Increase the separation between the equipment and receiver.
- Connect the equipment into an outlet on a circuit different from that to which the receiver is connected.
- Consult the dealer or an experienced radio/TV technician for help.

The device has been evaluated to meet general RF exposure requirement. This equipment should be installed and operated with a minimum distance of 20 cm between the radiator and your body.

## Attentions

- Product installation and commissioning should be done by a qualified professional.
- Our company products are and not lightningproof non-waterproof (special models excepted). Please avoid the sun and rain. When installed outdoors, please ensure they are mounted in a water proof enclosure or in an area equipped with lightning protection devices .
- Good heat dissipation will prolong the working life of products. Please ensure good ventilation.
- Please check if the working voltage used complies with the parameter requirements of products.
- The diameter of wire used must be able to load the light fixtures you connect and ensure the firm wiring.
- Before you power on products, please make sure all the wiring is correct.
- If a fault occurs, please do not attempt to fix products by yourself. If you have any question, please contact your suppliers.

## Warranty Agreement

- Warranty periods from the date of manufacture: 5 years.
  - Free repair or replacement services for quality problems are provided within warranty periods.
- Warranty exclusions below:
- Following conditions are not within the guarantee range of free repairing or replacement services:
- Beyond warranty periods.
  - Any artificial damage caused by high voltage, overload, or improper operations.
  - Products with severe physical damage.
  - Damage caused by natural disasters and force majeure.
  - Warranty labels and barcodes have been damaged.
  - No any contract or invoice signed by our company .
1. Repair or replacement provided is the only remedy for customers. Our company is not liable for any incidental or consequential damage unless it is within the law .
  2. Our company has the right to amend or adjust the terms of this warranty. The warranty that issues in writting shall prevail.
- \* This manual is subject to changes without further notice. Product functions depend on the goods. Please feel free to contact our official distributors if you have any question.