

# LTECH

## DALI Master (Super Dimming Module)

Model: CG-D-PRO



Manual

[www.ltech-led.com](http://www.ltech-led.com)

# Application Diagram

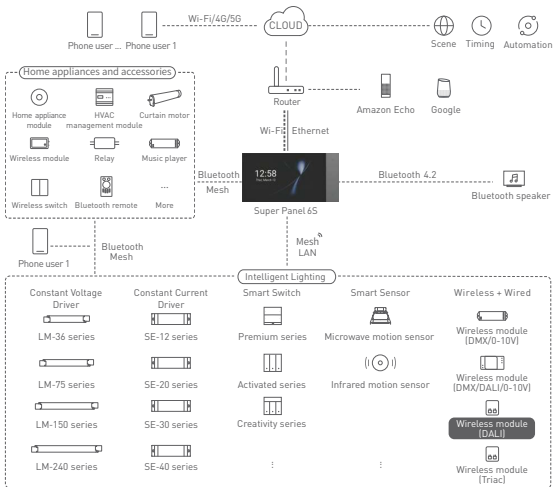

## Product Features

- Small size and light weight. The housing is made from SAMSUNG/COVESTRO's V0 flame retardant PC materials.
- Bluetooth 5.0 SIG Mesh with high networking capacity provides reliable and stable performance.
- The push-type terminals make it easy to attach wires.
- Support online upgrade and consume ultra-low power consumption.
- Compatible with DIM, CT, and RGB lights and control their output.
- Convert Bluetooth to DALI protocol; Merging the wireless and wired protocol allows more expanded applications.
- Provide multiple options for selecting dimming parameters to meet requirements of smart dimming and color control for demanding dimming places.
- Control up to 64 addresses, 16 groups, and scenes.
- Support the execution of local scenes without the Internet or a gateway, which is faster and more stable.

## Technical Specs

Model	CG-D-PRO
Wireless Protocol Type	Bluetooth 5.0 SIG Mesh
Output Signal	DALI
Number of addresses :	64
Input Voltage	12-22.5Vdc
Working Temperature	-20°C-55°C
Product Size[L×W×H]	59×52×20[mm]
Package Size[L×W×H]	86×86×25[mm]
Weight [G.W.]	40g



Bluetooth®



RoHS



# Product Images

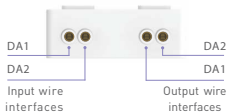

# Product Size

Unit: mm

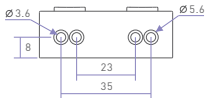
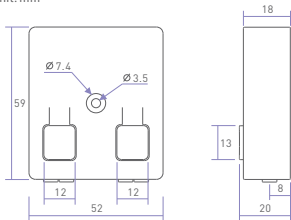

# Wiring Diagram

APP + Super Panel 6S + DALI bus power supply + DALI master + DALI driver

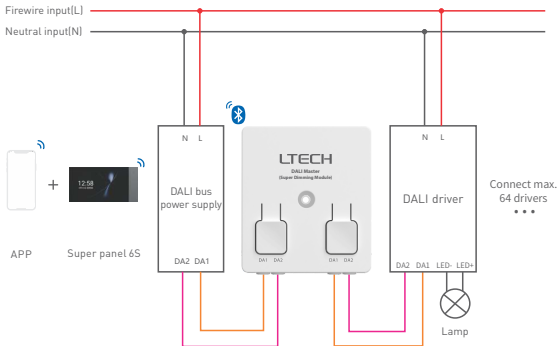

## Wire specifications

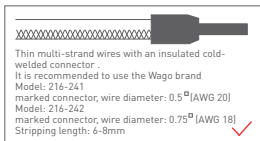
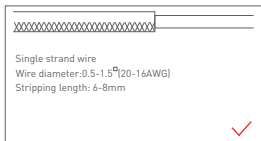
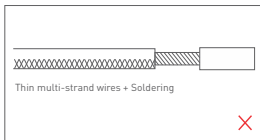
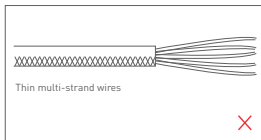

## Wire connection

**Connect wires:** Turn off the power before connecting wires. Press and hold the button on the top and make wires parallel to the wire port, then insert wires into the corresponding terminal until wires are locked.

**Release wires:** Turn off the power before releasing wires. Press and hold the button on the top and gently pull the wires out.

**Attentions:**

1. Please connect the wires based on the wire specifications. Otherwise the terminals will be easily damaged if the wire diameter is too big;
2. Press the terminals with proper force and keep it vertically downward.

# Recommended Applications

## 1. Wirelessly control the lamp

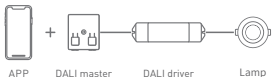

## 2. Visual control of the lamp via a smart switch with a screen.

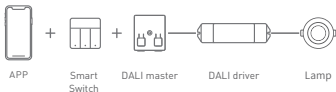

## 3. Support the execution of local scenes without the Internet or a gateway.

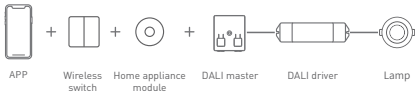

## 4. Visual control + Traditional dimming panel and remote controller control.

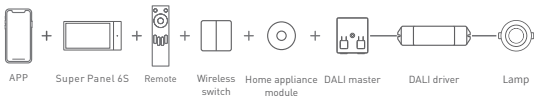

## 5. More applications of intelligent control are waiting for you to set up.

# Set DALI addresses

1.Scan the QR code below with you mobile phone and follow the prompts to complete the app installation.



Scan and download the App

- 2.Set up the DALI drivers with the NFC Lighting APP. The address range is between 0 and 63, and the address number cannot be repeated.
- 3.Connect the DALI drivers with the set addresses to the corresponding terminals of the DALI master (CG-D-PRO) according to the connection diagram on Page 4. Max. 64 drivers are supported.

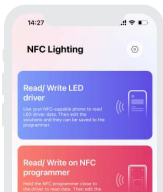



# App Operating Instructions

## 1. Register an account

1.1 Scan the QR code below with you mobile phone and follow the prompts to complete the app installation.



Scan and download the App

## 2. Pairing instructions

Create a home if you are a new user. Click “+” icon in the upper right corner and access the “Add device” page. Pick “Smart module” - “Super dimming module” from the list. Connect the device to the DALI bus power supply and power it on. Make sure the device is not connected to the network, then click “Search via Bluetooth ” and follow the prompts to add the device.

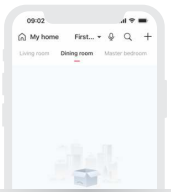

### 3. Search DALI address

Confirm that the address number of DALI drivers are not repeated and the wire connection has been done correctly according to the wiring diagram on page 4. Then power on the drivers and click "Search address" to wait for the address to be searched successfully.

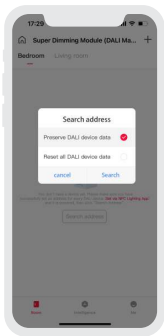

## 4. DALI addressable light control: groups and addresses

**DALI address control:** In the **【Groups & Addresses】** interface, click the corresponding cards for the addressable lights. You'll be able to individually control the lighting effect of each light with address between 0 and 63. The control method is the same as that of Bluetooth lights.

**DALI group control:** In the **【Groups & Addresses】** interface, click the group card or enter the settings page. Click "Manage the addresses of group lights " and add addressable lights between 0 and 63 to DALI groups from No.0 to No.15 to perform group control. The control method is the same as that of Bluetooth group lights.

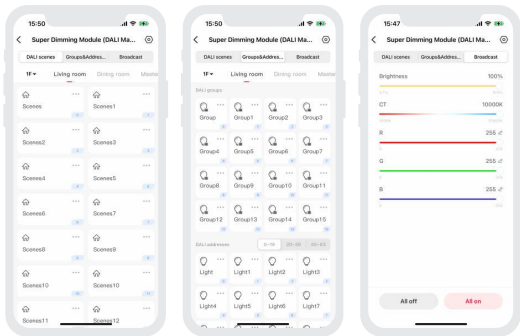

## 5. DALI addressable light control: DALI scenes and broadcast

**DALI scene control:** In the **[DALI scenes]** interface, set 64 addressable lights and 16 DALI groups as actions in DALI scenes. After saving them successfully, you can go to Settings page and click "Edit action". Or you can long press the corresponding cards of addressable lights and groups to modify the actions more quickly.

**Broadcast control:** In the **[Broadcast]** interface, you can simultaneously control on/off and brightness of all DALI addressable lights, as well as K value of CT lights and R, G, B value of RGB lights.

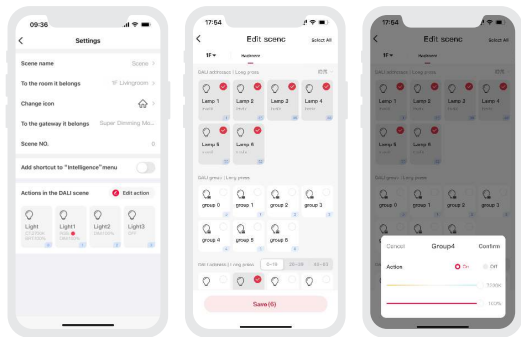

## 6. Batch setting for DALI addressable lights

Set parameters in batch: Click "⊞" in the upper right corner of "DALI master - Super dimming module" interface, then click "Batch Settings". Pick one or more addressable lights to change parameters. You can click "Change parameter" or "Change room" to batch modify DALI lighting parameters or assigned rooms for one or more addressable lights.

Add quick management in batch: Click "..." in the upper right corner of **[DALI master-Super dimming module]** to enter the settings page, then click "Add quick management" to select the DALI addresses/groups of which you want to batch add/cancel shortcuts.

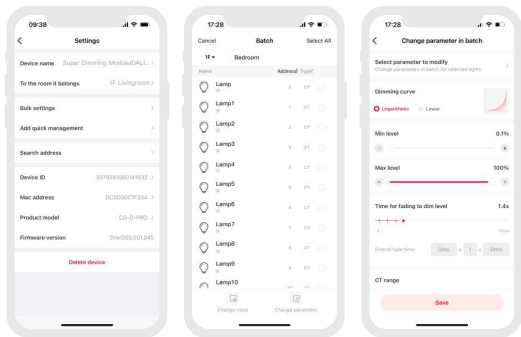

## 7. Panel binding

Click the added smart switch in the "Room" interface to enter its **【Control】** interface. Long press the corresponding button in the interface or go to the **【Settings】** interface by clicking "⊙" to select "Device- DALI master-Super dimming module". Then select the corresponding action for a DALI scene, a group, a addressable light or broadcast that you want to bind to the smart switch.

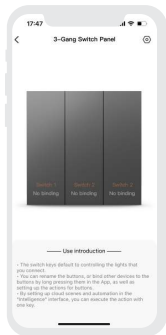

## 8. Local scene

Switch to the "Intelligence" interface, click [ + ] in the upper right corner to create a local scene. After setting the execution action, you can achieve local linkage with Bluetooth devices.

- \* When you edit the action for a local scene and a shortcut has been added to the DALI scene/group/ addressable light , the editing steps will be shortened.

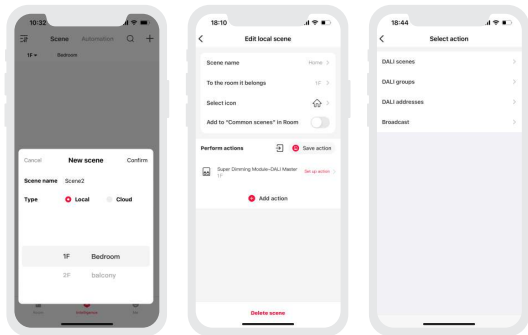

## 9. Cloud scene and automation

Make sure a smart gateway has been added to your home, such as Super Panel 6S.

Cloud scene: Switch to the "Intelligence" interface and click **[ + ]** to create a cloud scene.

After setting the execution action, remote linkage can be achieved.

Click **[Automation]** in the "Intelligence" interface and click **[ + ]** to create automation.

You can choose the local or cloud execution mode, and set trigger conditions and execution actions. When the trigger conditions you set are met, a series of device actions will be automatically triggered to achieve remote linkage.

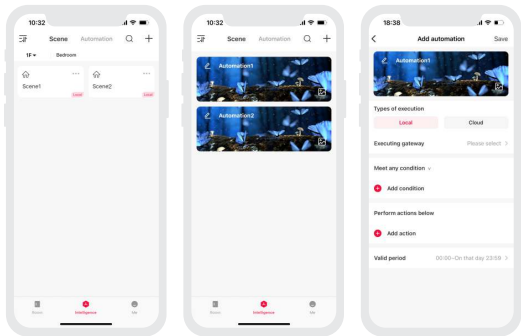



## FAQs

### 1. What should I do if I fail to search the device via APP?

Please check below:

- 1.1 Please make sure the device is powered on normally and is in the activated state.
- 1.2 Please keep your mobile phone and device as close as possible. The recommended distance between them is no more than 15 meters.
- 1.3 Please make sure the device hasn't been added yet. If it has, please reset the device to factory defaults manually.

### 2. How to reset the device to factory defaults?

Make sure "DALI master-Super dimming module" has been correctly connected to the DALI lamp that remains on. Use the switch to turn on/off the DALI master for 6 consecutive times (turn it off and 5s later turn it on. 2s later turn it off again). Repeat the turn-on-off operation for 6 times. When the lamp flashes 5 times, it means that the DALI master has been reset to factory defaults.

## Attentions

- Products shall be installed by qualified professionals
- LTECH products are and not lightningproof non-waterproof (special models excepted). Please avoid the sun and rain. When installed outdoors, please ensure they are mounted in a water proof enclosure or in an area equipped with lightning protection devices.
- Good heat dissipation will prolong the working life of products. Please ensure good ventilation.
- Please check if the working voltage used complies with the parameter requirements of products.
- The diameter of wire used must be able to load the light fixtures you connect and ensure the firm wiring.
- Before you power on products, please make sure all the wiring is correct in case of incorrect connection that causes damage to light fixtures.
- If a fault occurs, please do not attempt to fix products by yourself. If you have any question, please contact your suppliers.

\*This manual is subject to changes without further notice. Product functions depend on the goods. Please feel free to contact our official distributors if you have any question.

# Warranty Agreement

Warranty periods from the date of delivery: 2 years.

Free repair or replacement services for quality problems are provided within warranty periods.

## **Warranty exclusions below:**

- Beyond warranty periods.
  - Any artificial damage caused by high voltage, overload, or improper operations.
  - Products with severe physical damage.
  - Damage caused by natural disasters and force majeure.
  - Warranty labels and barcodes have been damaged.
  - No any contract signed by LTECH.
1. Repair or replacement provided is the only remedy for customers. LTECH is not liable for any incidental or consequential damage unless it is within the law.
  2. LTECH has the right to amend or adjust the terms of this warranty, and release in written form shall prevail.